

Balustrade Brochure

GLASS BALUSTRADES | BALUSTER RAILINGS | HANDRAILS



Where Promises Turn Into Results

As balustrade specialists, we provide complete support at every stage from initial planning to the final installation. Whether you're ready to place an order or need a customized solution for your project, our team is here to guide and assist you.



Planning



Support



Ready



Success

From the initial concept and detailed design to expert guidance and final installation, we ensure every step of your project runs smoothly and delivers outstanding results.



From the earliest planning stage to the final finished result, our team ensures every aspect of your balustrade project is handled professionally. We provide technical guidance, customized design options, quality materials, and precise installation to guarantee a smooth and successful outcome.

И Metal



Metal





Strength in Safety, Beauty in Design

Our balustrades are built to deliver both protection and style. Designed with precision and installed by experienced professionals, they provide reliable safety while complementing your architectural design. We offer multiple styles, materials, and finishes to suit every project and budget.

HH Metal



All base shoes are available with the adjustable or non-adjustable System.

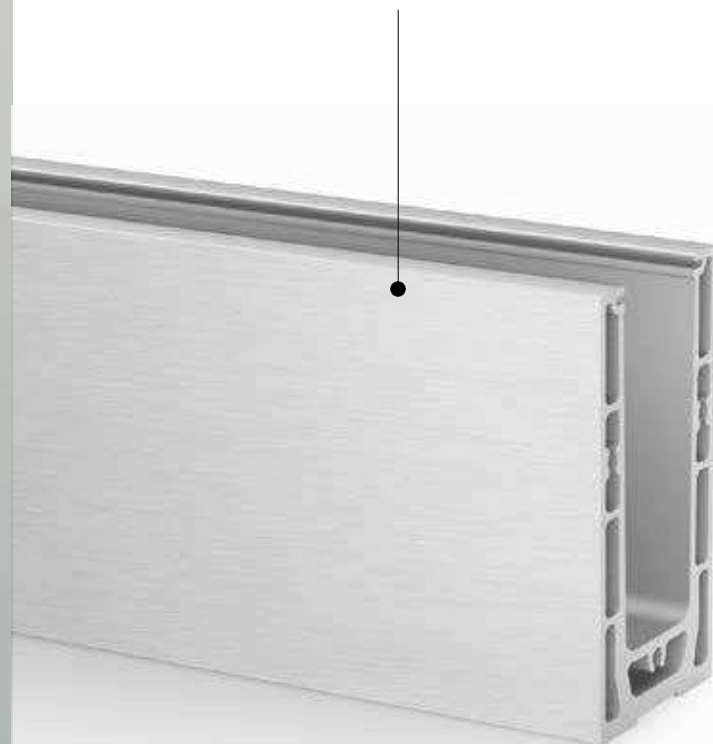

Reliable support from idea to finished result.

As balustrade specialists, we provide complete support at every stage of your project from initial consultation and design planning to precise fabrication and final installation. Our experienced team works closely with you to understand your requirements, deliver customized solutions, and ensure high-quality results that meet both safety standards and aesthetic expectations.





Options

Infill



Glass

Top finish



Edge protection



Cap rails, round



Cap rail, angular



Handrail, round



Handrail, angular



Aluminium



Stainless steel



Wood

LED lighting



Spotlight



Linear Light

Extras



Trims for cladding



Trims for flooring



Drainage profiles



Shims

Prefabrication



Cutting



2D bending



Powdercoating

Glass variants



Smart Top mount

- Also for in-floor mounting

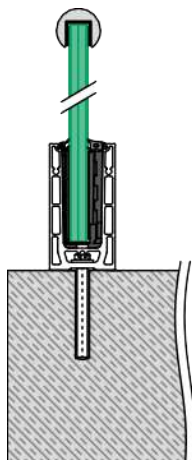

Smart F Top mount

- For unfinished floors
- Can be installed at or beyond the edge of a surface

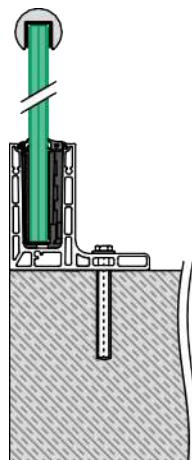

Smart Fascia mount

- Also for mounting on the inner side of parapet walls
- Base channel cladding available

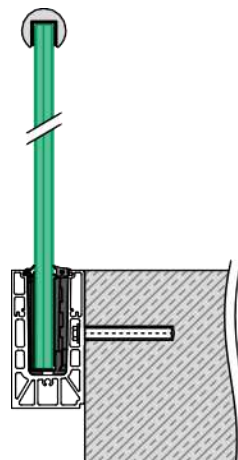

Smart Y Fascia mount

- For unfinished floors
- Can be installed at or beyond the edge of a surface
- Base channel cladding available

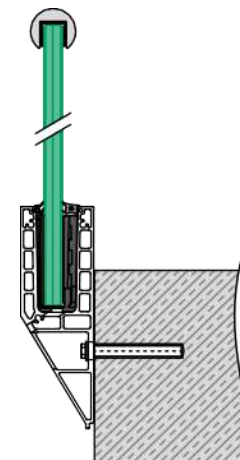

Max. line load (kN/m)

UK	DE/AT	NL	IT	CH	ES	FR	PL	BE	NO	DK/SE/FI
0,74	1,0	0,8	>2,0	1,6	3,0	1,0	2,0	1,0	1,0	1,0

Please refer to the respective certificates for specifications such as mounting details, glass dimensions and glass types.

Internationally tested/calculated/certified:



The adjustable Q-disc® System – slide and align!

0,6°



Easy Glass Smart advised use

	MOD 8220	MOD 8230	MOD 8240	MOD 8210	Safety glass	
INDOOR <input type="checkbox"/>	<input type="checkbox"/>	<input type="checkbox"/>	<input type="checkbox"/>	<input type="checkbox"/>	16,76 - 17,52 mm	<input type="checkbox"/> Domestic use 0,50 kN/m
OUTDOOR	<input type="checkbox"/>	1,4	1	1		
Wind load (kN)						
INDOOR <input type="checkbox"/>	<input type="checkbox"/>	<input type="checkbox"/>	<input type="checkbox"/>	<input type="checkbox"/>	20,76 - 21,52 mm*	<input type="checkbox"/> Public use 1,00 kN/m
OUTDOOR		0,8	1	1,5		
Wind load (kN)	0,6					

* Only with non-adjustable Qdisc system





Easy Glass Smart+ High variants

Smart+ High is specially developed for high floor structures.

HH Metal

Smart+ High F Top mount

- No substructure needed
- No additional calculations required
- Compatible with trims and accessories from our Smart+ range

Smart+ High Y Fascia mount

- No substructure needed
- No additional calculations required
- Base channel cladding available

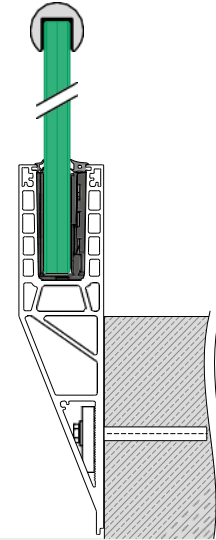
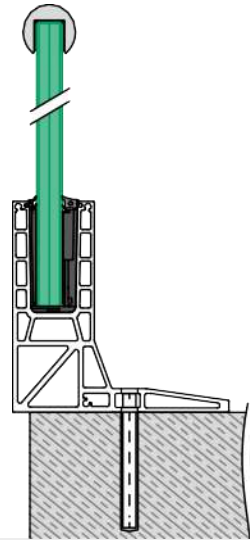









THE GLASS
BALUSTRADE
FOR PARAPET
WALLS

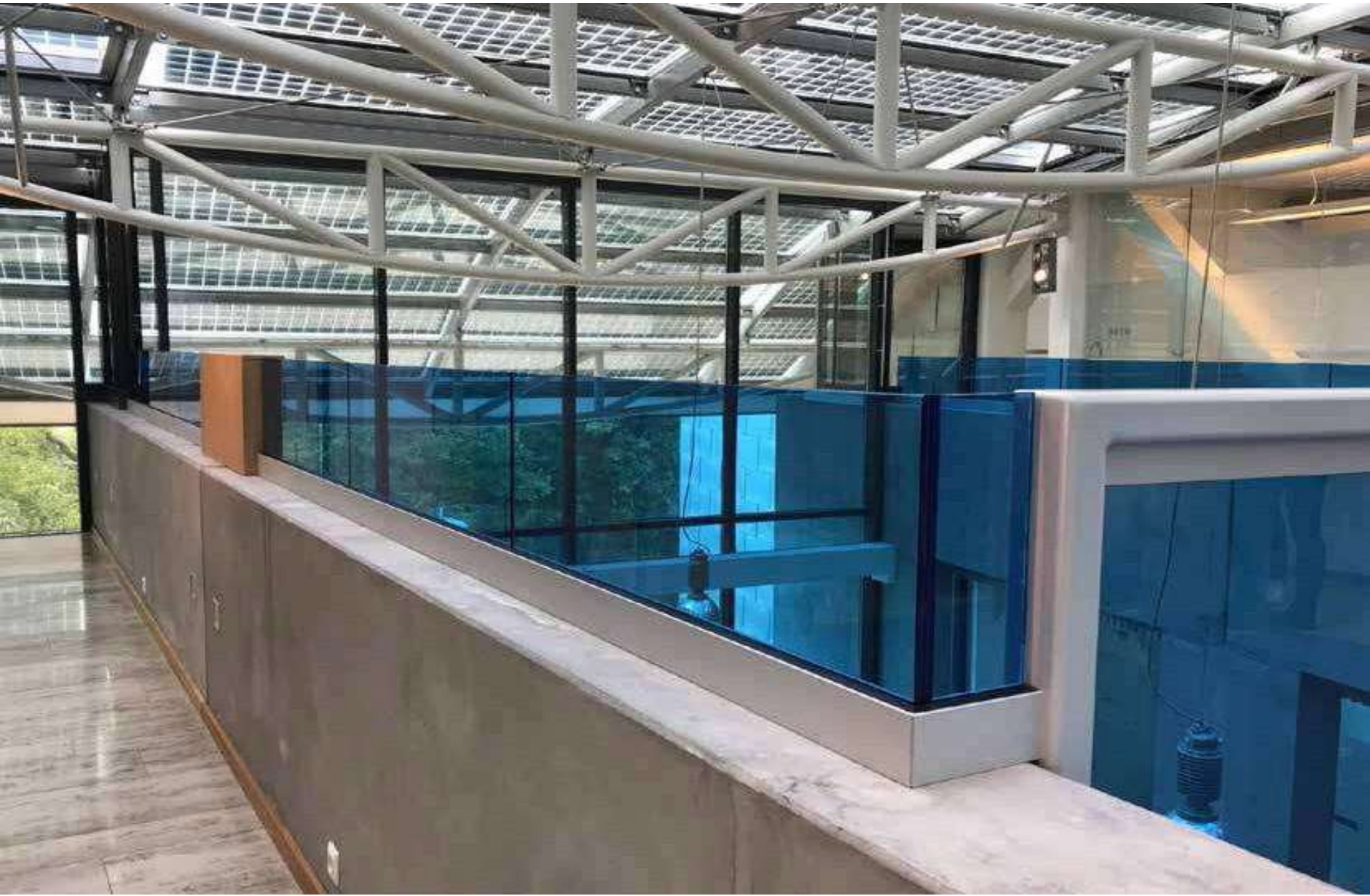





THE CLEAR
ANSWER
TO BALCONIES







Elegant base glass clamp with satined and glass-bead blasted surfaces.



ELEGANT
BASE

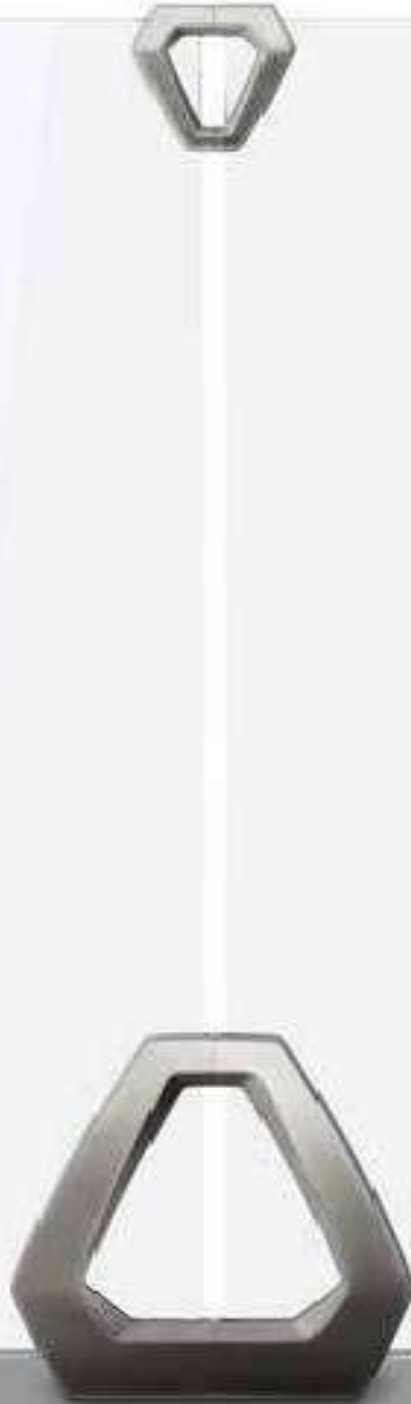



ELEGANT
BASE



BASE
GLASS
CLAMPS





HH Metal





GLASS ADAPTERS



 Metal

BLOCK GLASS ADAPTERS

BLOCK GLASS ADAPTERS

HH Metal





POINT GLASS ADAPTERS



POINT GLASS ADAPTERS

INDOOR &
OUTDOOR SYSTEM

HIGH-GRADE ALUMINIUM RAILING





1 Ready-to-install modules



2 Prefabricated single components



3 Standard single components





SQUARE
LINE

Creates a contemporary look thanks to its industrial design.



SQUARE
LINE



SQUARE LINE





SQUARE LINE

SQUARE LINE



Square Line® 60x30 Top mount

- Matching handrail brackets, connectors and cover caps available



Square Line® 60x30 Fascia mount

- Also for in-floor mounting
- Matching base flanges, baluster brackets, handrail brackets, connectors and cover caps available

The HH-line range is extremely versatile, with various surface and infill options, top and fascia mounting, and even stair solutions.



HH-LINE





H Metal





Spigot Fixing
Top mount



Spigot Fixing Glass Link Top mount



Two Point Fixing
Fascia mount



Blok Fixing
Fascia mount



Blok Fixing Full Glass
Fascia mount



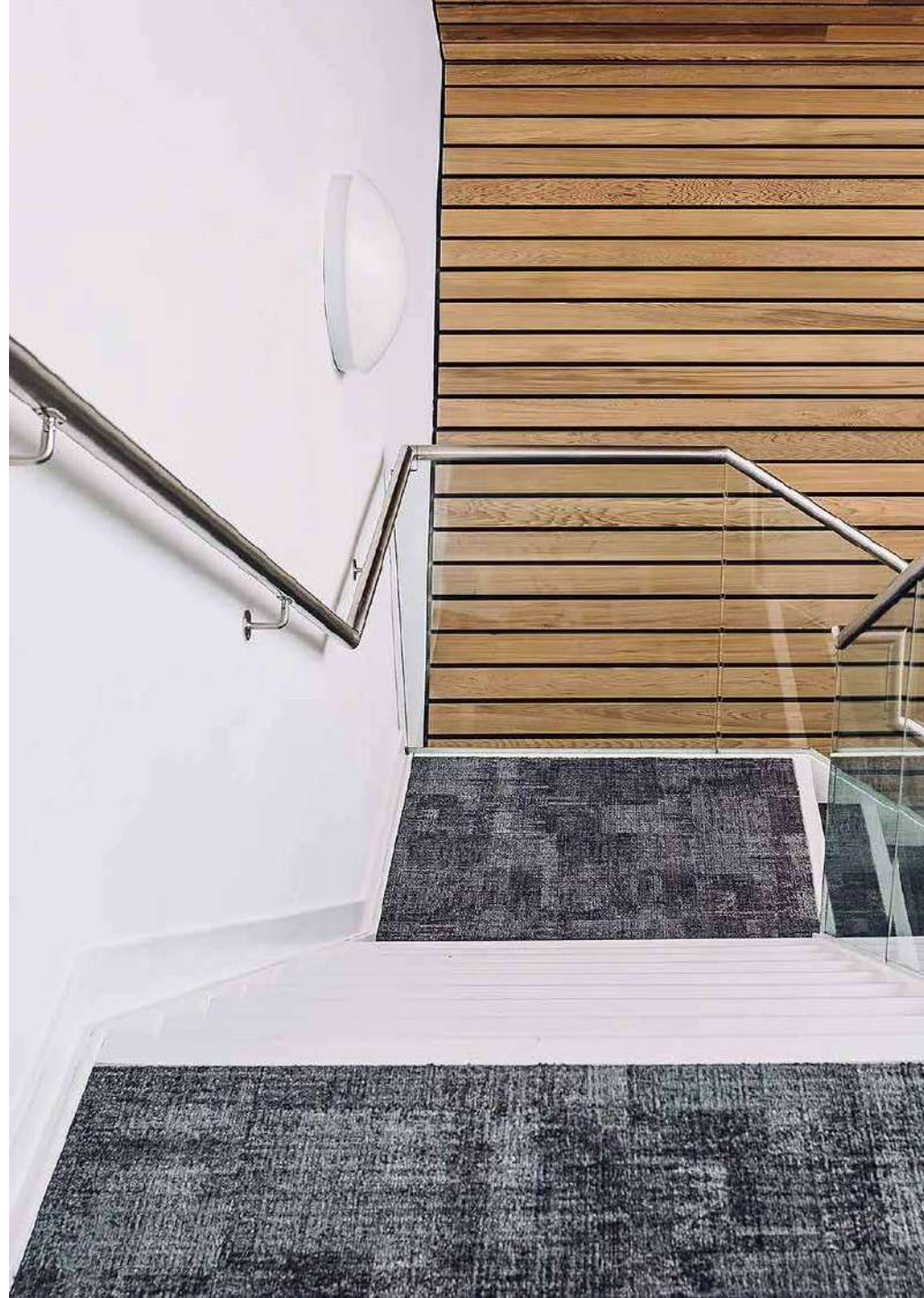

HANDRAILS



Edge Protection

Glass Mounted

Post Mounted

Wall Mounted

Cap rails

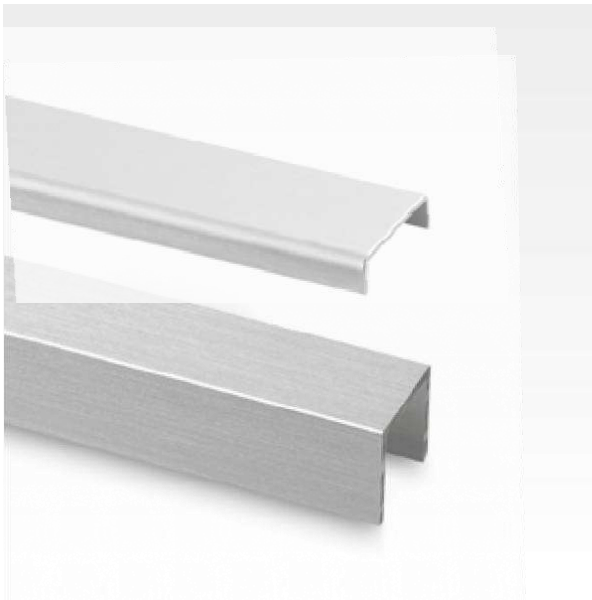

CAP RAILS AND EDGE PROTECTION

Options

LED lighting



Linear Light

Prefabrication



Cutting



2D/3D bending



Powdercoating



Preassembly



Drilling

LED LIGHTING



LINEAR LIGHTING

HH Metal



SPOT LIGHTING





Q-glass



Powder coating



Prefabrication



Tests and certificates



HH-GLASS

Order glass at the same time as you order the rest of your railing

Glass from stock

- Available immediately
- Toughened laminated glass
- 8,76 - 16,76 mm, 10 widths and 3 heights
- Smooth, arised and polished edges
- Rounded corners

Bespoke made glass

- From monolithic glass to 31,52 mm toughened laminated glass
- Optional coloured or SentryGlas® interlayers
- Radius corners and polished edges on request
- Optional pre-drilled holes

- CE marked
- High quality
- Accurate delivery times and notification
- Clearly quoted competitive prices
- Straightforward ordering

Powder coating

Conveniently add powder coating when you order base channels, tubes, end caps or any other components you want to customise with colour. Choose any RAL colour you like.





Prefabrication



Bending

We can carry out 2D or 3D bending to order on tubular components, cap rails, U-profiles, edge protection top rails and even base channels. This meticulous service will ensure that you get exactly the sizes and deflections you need.



Cutting and drilling

For maximum convenience, ask us to pre-cut stainless steel, aluminium or wooden products. We can also drill and tap the balusters or handrails based on your exact specifications.



Welding

On rare occasions, HH-railing's standard products require welding in order to fit a particular situation. But this is no problem – let us pre-weld your custom-made products.



Pre-assembly

To receive HH-railing products pre-assembled in accordance with your needs, simply order our prefix service. Imagine how much time it would save if, for example, your glass clamps or crossbar holders were pre-installed before delivery.



Choose from our wide range of high-quality components to create the perfect indoor or outdoor glass railing. We offer top-mount and fascia-mount systems, along with specialized solutions for Juliet balconies and parapet walls.



Choose from our wide range of high-quality components to create the perfect indoor or outdoor glass railing. We offer top-mount and fascia-mount systems, along with specialized solutions for Juliet balconies and parapet walls.

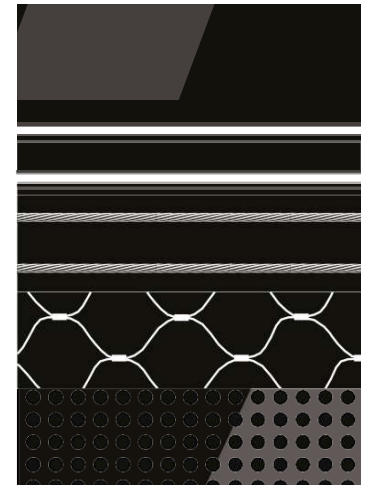
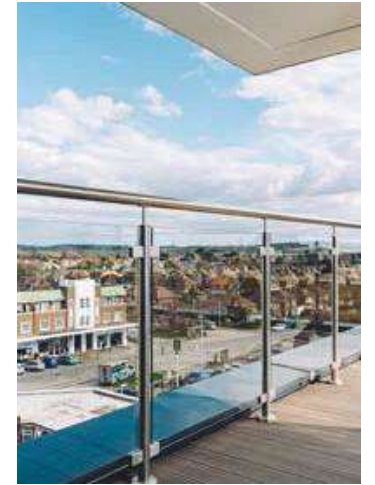
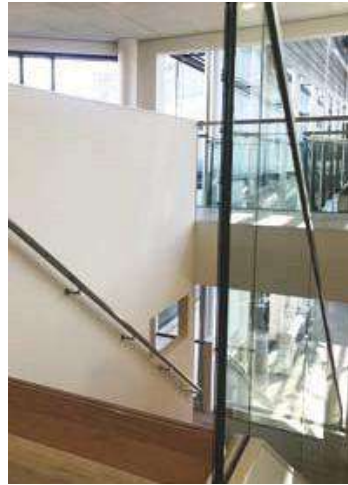

Choose from our wide range of high-quality components to create the perfect indoor or outdoor glass railing. We offer top-mount and fascia-mount systems, along with specialized solutions for Juliet balconies and parapet walls.

STRONG GLASS

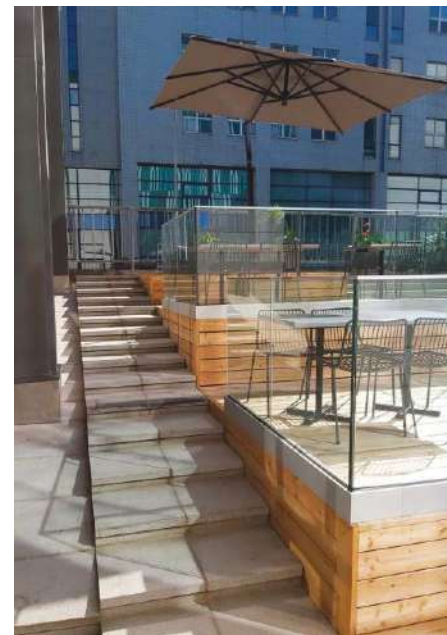
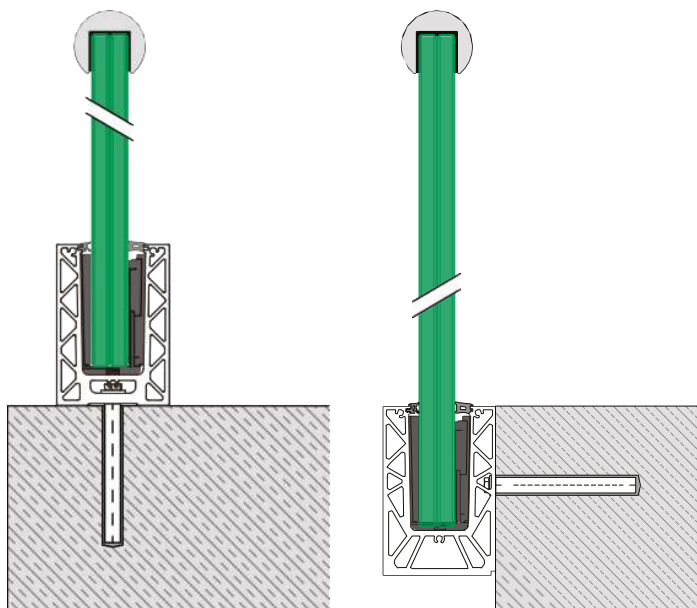
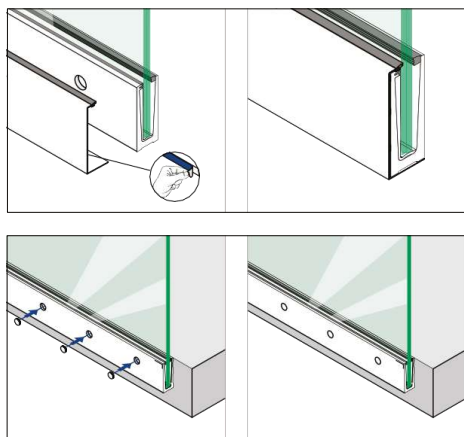

Choose from our wide range of high-quality components to create the perfect indoor or outdoor glass railing. We offer top-mount and fascia-mount systems, along with specialized solutions for Juliet balconies and parapet walls.



STRONG GLASS





SIMPLE DESIGN

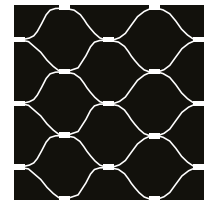



SIMPLE DESIGN

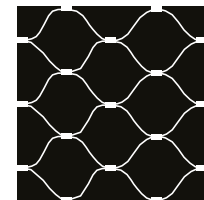



STAINLESS STEEL TUBES
FROM HH-METAL



BENDED TUBES



BARRIER LINE



MIRROR POLISHED

HH Metal

SIMPLE



DESIGN



9H Metal

COLLECTION



SIMPLE
DESIGN

COLLECTION

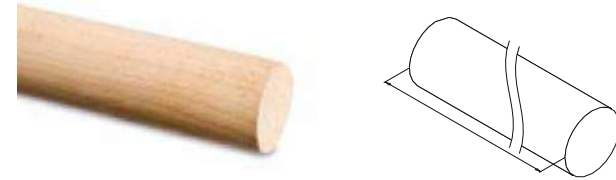

BENDED WOOD HANDRAIL

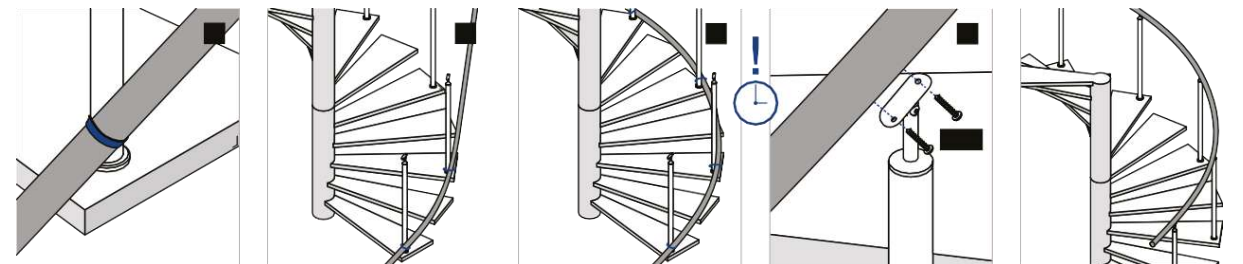

HH Metal



HH-METAL
INFILLS GLASS



INFILLS

BAR AND

TUBE

INFILLS BRAND TUBE

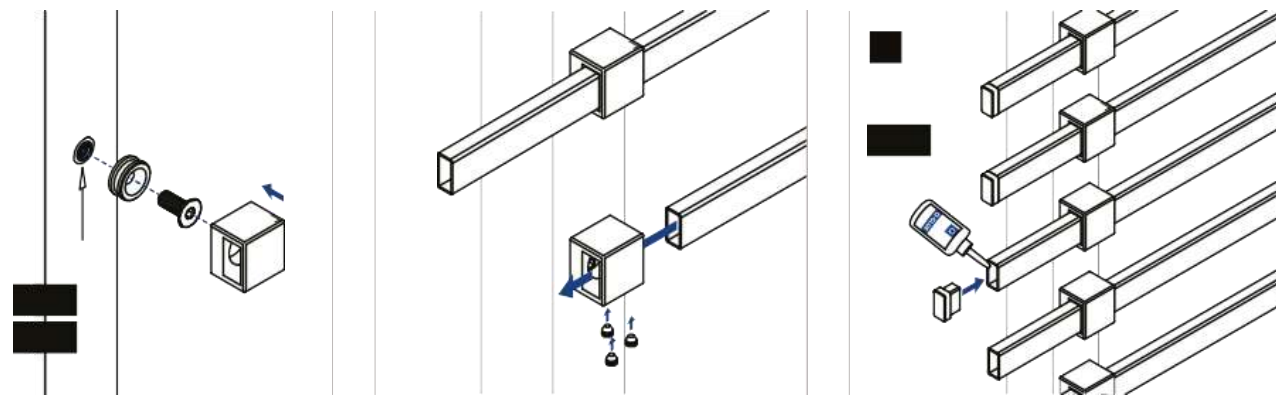

INFILLS CABLE

9H Metal

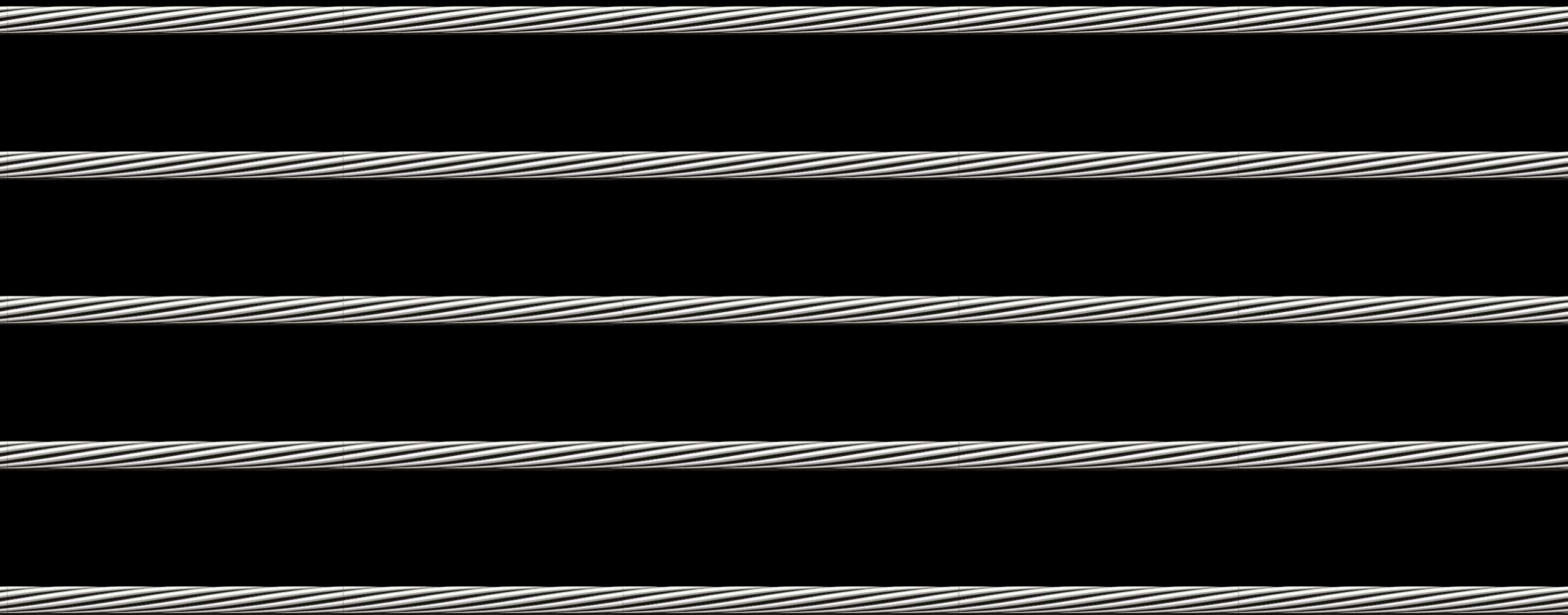

PICKET RAIL INFILL

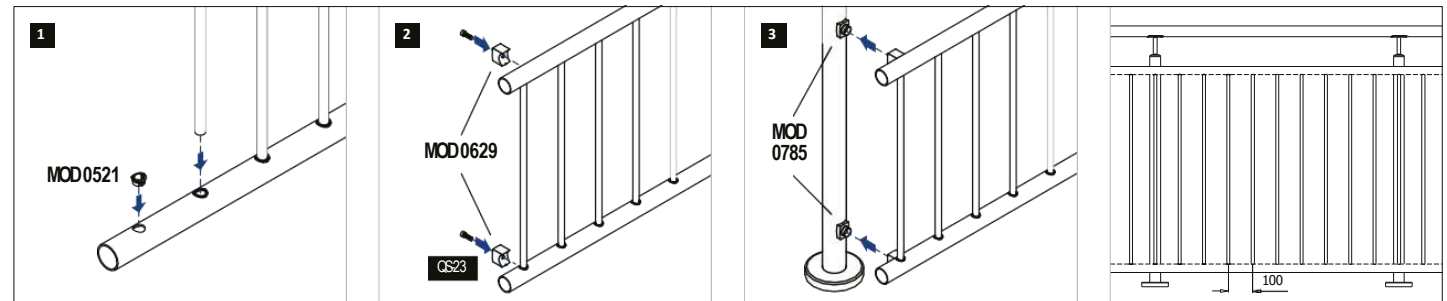
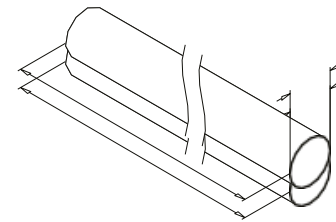

Choose from our wide range of high-quality components to create the perfect indoor or outdoor glass railing. We offer top-mount and fascia-mount systems, along with specialized solutions for Juliet balconies and parapet walls.

HH Metal

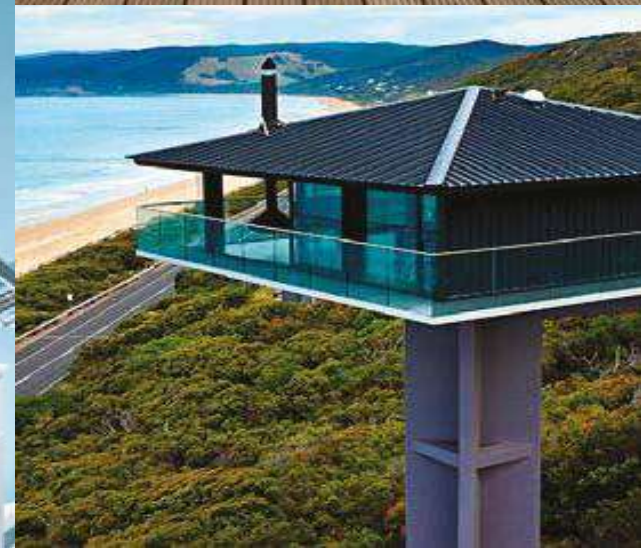
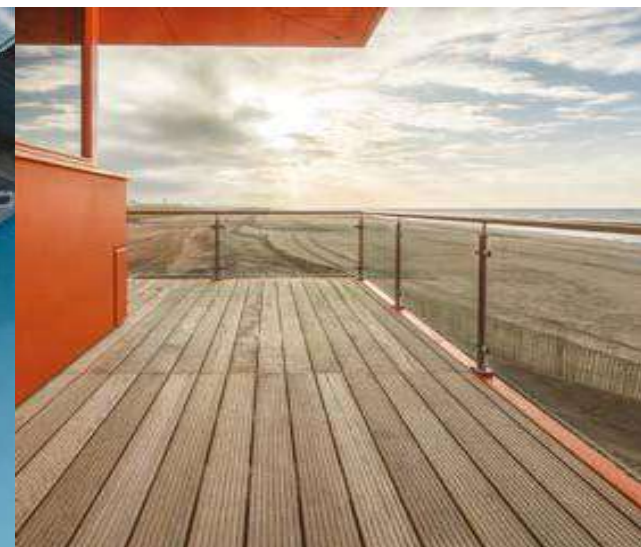
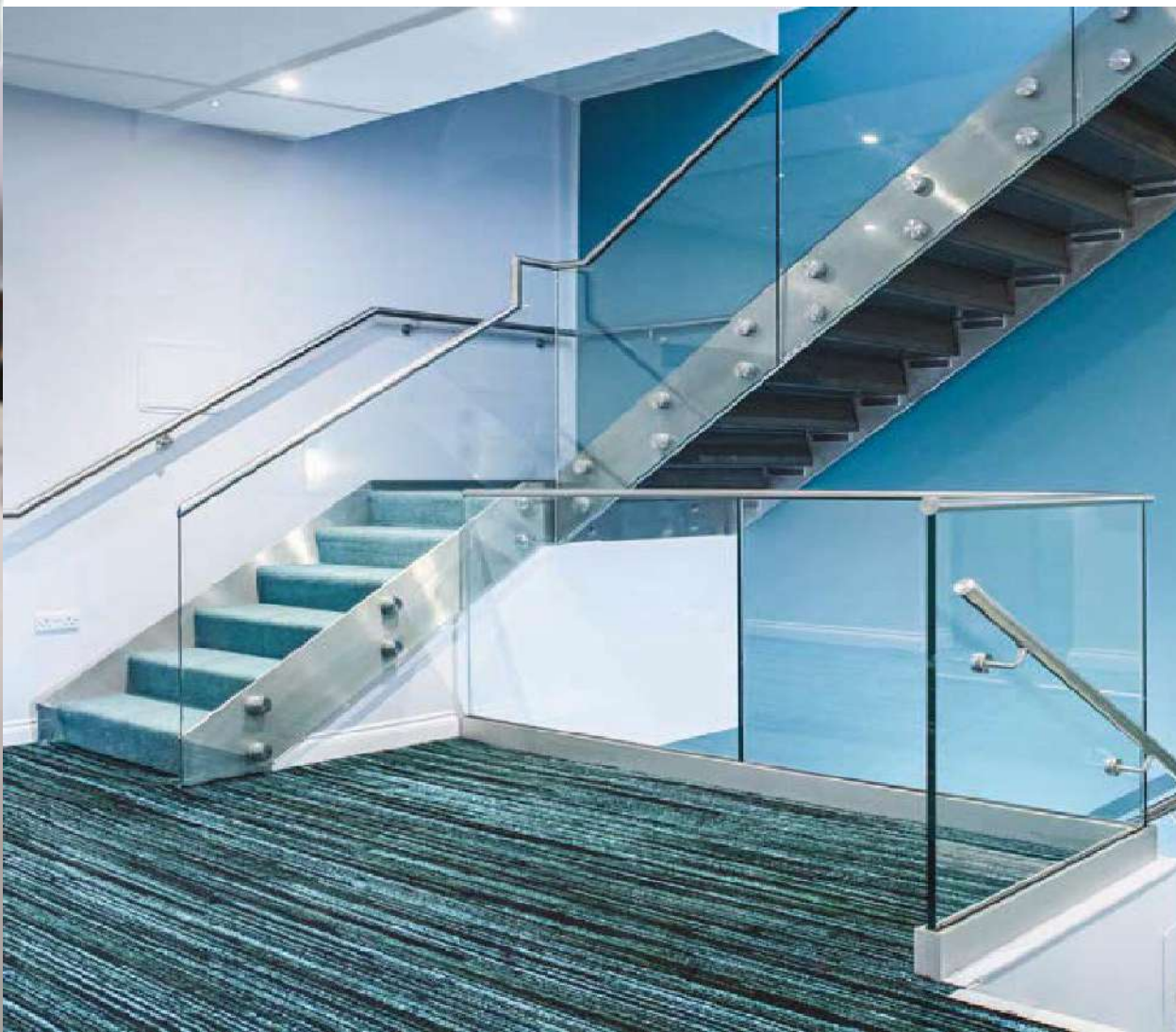

HANDRAIL & GLASS FITTINGS

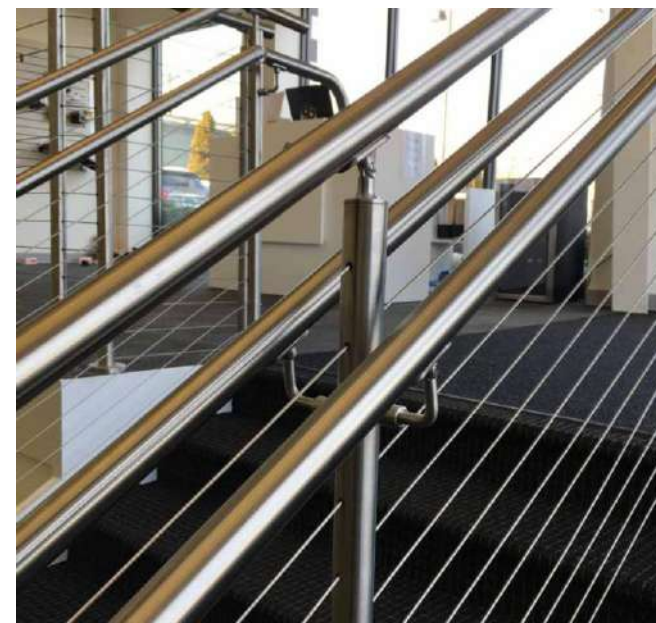

PATCH FITTINGS & ACCESSORIES

Door thickness: 10-12mm toughened glass
Material: SS304, Aluminum alloy
Finish: Polish, Satin, Gold, Black



HF-10
Bottom Door Patch

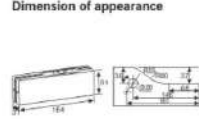

Door thickness: 10-12mm toughened glass
Material: SS304, Aluminum alloy
Finish: Polish, Satin, Gold, Black



HF-20
Top Door Pivot Patch

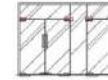
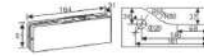

Door thickness: 10-12mm toughened glass
Material: SS304, Aluminum alloy
Finish: Polish, Satin, Gold, Black



HF-30
Top Fixed Panel Pivot Patch

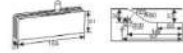

Door thickness: 10-12mm toughened glass
Material: SS304, Aluminum alloy
Finish: Polish, Satin, Gold, Black



HF-30K
Top Fixed Panel Lock Slot Patch



Door thickness: 10-12mm toughened glass
Material: SS304, Aluminum alloy
Finish: Polish, Satin, Gold, Black



HF-40
Over Panel Patch With Pivot

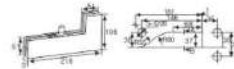

Door thickness: 10-12mm toughened glass
Material: SS304, Aluminum alloy
Finish: Polish, Satin, Gold, Black



HF-40K
Over Panel Patch Without Pivot



PATCH FITTINGS & ACCESSORIES

Door thickness: 10-12mm toughened glass
Material: SS304, Aluminum alloy
Finish: Polish, Satin, Gold, Black



HF-50K
Mid Panel With Lock Slot

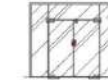

Door thickness: 10-12mm toughened glass
Material: SS304, Aluminum alloy
Finish: Polish, Satin, Gold, Black



HF-50S/CL
Door Centre Lock Patch

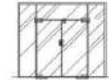
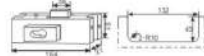

Door thickness: 10-12mm toughened glass
Material: SS304, Aluminum alloy
Finish: Polish, Satin, Gold, Black



HF-50S/R
Door End Corner Patch



Door thickness: 10-12mm toughened glass
Material: SS304, Aluminum alloy
Finish: Polish, Satin, Gold, Black



HF-50 2K
Mid Panel With Lock Slot

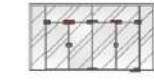

Door thickness: 10-12mm toughened glass
Material: SS304, Aluminum alloy
Finish: Polish, Satin, Gold, Black



HF-50S/T
Door End Corner Patch

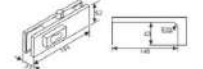

Door thickness: 10-12mm toughened glass
Material: SS304, Aluminum alloy
Finish: Polish, Satin, Gold, Black



HF-80
Square Type

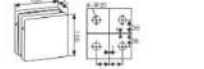

PATCH FITTINGS & ACCESSORIES



HF-60
Top Door Pivot Patch

Door thickness: 10-12mm toughened glass
Material: SS304, Aluminum alloy
Finish: Polish, Satin, Gold, Black

Dimension of appearance

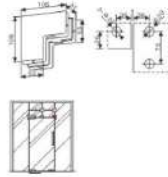

HF-67
Bottom Door Patch

Door thickness: 10-12mm toughened glass
Material: SS304, Aluminum alloy
Finish: Polish, Satin, Gold, Black

Dimension of appearance

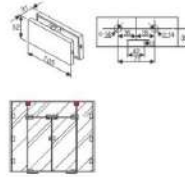

HF-82
Top Door Pivot Patch

Door thickness: 10-12mm toughened glass
Material: SS304, Aluminum alloy
Finish: Polish, Satin, Gold, Black

Dimension of appearance

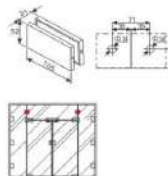

HF-07

Door thickness: 10-12mm toughened glass
Material: SS304, Aluminum alloy
Finish: Polish, Satin, Gold, Black

Dimension of appearance

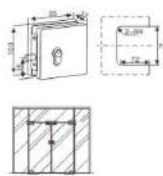

HF-07K

Door thickness: 10-12mm toughened glass
Material: SS304, Aluminum alloy
Finish: Polish, Satin, Gold, Black

Dimension of appearance

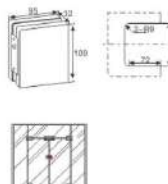

HF-08

Door thickness: 10-12mm toughened glass
Material: SS304, Aluminum alloy
Finish: Polish, Satin, Gold, Black

Dimension of appearance

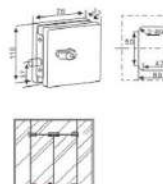

PATCH FITTINGS & ACCESSORIES



HF-08k

Door thickness: 10-12mm toughened glass
Material: SS304, Aluminum alloy
Finish: Polish, Satin, Gold, Black

Dimension of appearance



HF-34

Door thickness: 10-12mm toughened glass
Material: SS304, Aluminum alloy
Finish: Polish, Satin, Gold, Black

Dimension of appearance

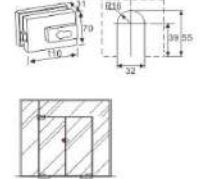

HF-34R

Door thickness: 10-12mm toughened glass
Material: SS304, Aluminum alloy
Finish: Polish, Satin, Gold, Black

Dimension of appearance

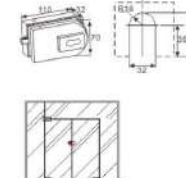

HF-81

Door thickness: 10-12mm toughened glass
Material: SS304, Aluminum alloy
Finish: Polish, Satin, Gold, Black

Dimension of appearance

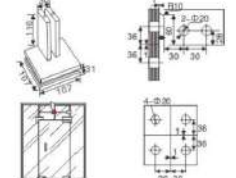

HF-9002
Top Door Pivot Patch

Door thickness: 10-12mm toughened glass
Material: SS304, Aluminum alloy
Finish: Polish, Satin, Gold, Black

Dimension of appearance
φ 14mm/17mm



HF-45

Door thickness: 10-12mm toughened glass
Material: SS304, Aluminum alloy
Finish: Polish, Satin, Gold, Black

Dimension of appearance

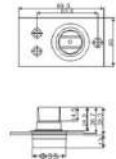

HF-9001
Bottom Door Pivot

Door thickness: 10-12mm toughened glass
Material: SS304, Aluminum alloy
Finish: Polish, Satin, Gold, Black

Dimension of appearance

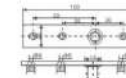

cylinder key-60

Door thickness: 10-12mm toughened glass
Material: Zinc-brass
Finish: Polish, Satin, Gold, Black

FLOOR SPRING



HF-650/D

Cement Box Size: 275x110x40mm
 Cover Size: 290x130mm
 Front and Back Adjust ± 5 mm
 Capacity: 120kg
 Door Width: 1000mm
 Dorma/Mab

Maximum Closing Time ≥ 46 s
 Minimum Closing Time ≤ 3 s
 Max Open Degree 105°
 90° HO or NHO

Dimension of appearance

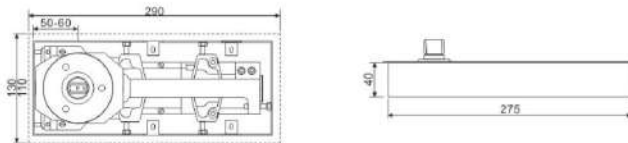

FLOOR SPRING



HF-860/D

Cement Box Size: 275x109x40mm
 Cover Size: 290x115mm
 Front and Back Adjust ± 5 mm
 Door Width: 850mm/1000mm
 Capacity: 120kg/100kg
 Dorma

Interchangeable Spindle, Up to 50mm
 Maximum Closing Time ≥ 46 s
 Minimum Closing Time ≤ 3 s
 90° HO or NHO
 Max Open Degree 105°

Dimension of appearance

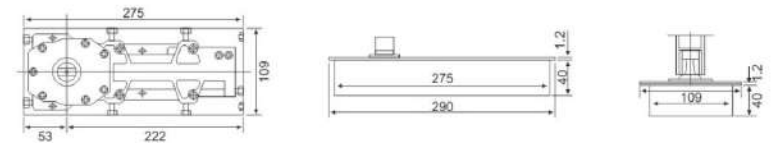

FLOOR SPRING



HF-840/D

Cement Box Size: 304x106x44mm
 Cover Size: 310x130mm
 Front and Back Adjust ± 5 mm
 Door Width: 1100/1000mm
 Capacity: 130kg/100kg
 Dorma/Mab

Interchangeable Spindle, Up to 50mm
 Maximum Closing Time ≥ 46 s
 Minimum Closing Time ≤ 3 s
 90° HO or NHO
 Max Open Degree 105°
 D/B

Dimension of appearance

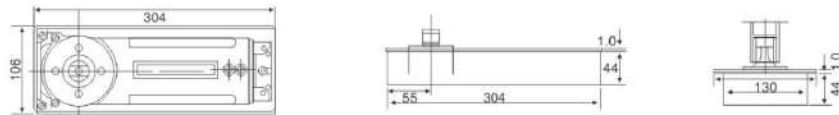

FLOOR SPRING



HF-850/B

Cement Box Size: 279x133x66mm
 Cover Size: 291x150mm
 Front and Back Adjust ± 5 mm
 Door Width: 1500mm/1300mm/1000mm
 Capacity: 150kg/130kg/100kg
 Dorma/Mab

Interchangeable Spindle, Up to 50mm
 Maximum Closing Time ≥ 46 s
 Minimum Closing Time ≤ 3 s
 90° HO or NHO
 Max Open Degree 105°
 D/B

Dimension of appearance

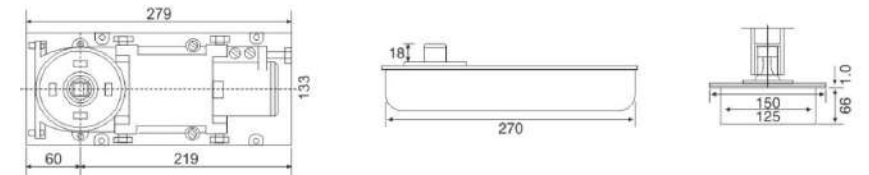

HYDRAULIC HINGE



HF-109

Cement Box Size: 190x70x40mm
 Door Width: 800mm/900mm
 Capacity: 80KG/100KG

Interchangeable Spindle, Up to 50mm
 Maximum Closing Time \geq 46s
 Minimum Closing Time \leq 3s
 90° HO or NHO
 Max Open Degree 150°
 Finish - Polish/Satin

Dimension of appearance

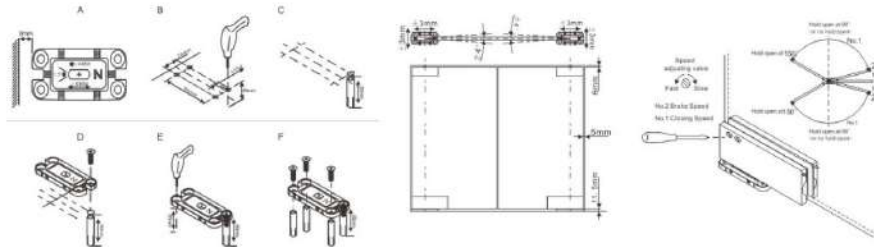

DOOR CLOSER & GLASS ACCESSORIES

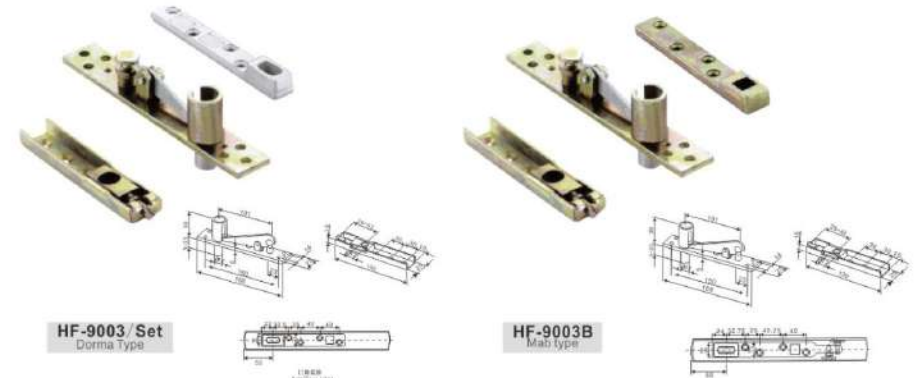

HF-9003/ Set
Dorma Type

HF-9003B
Mat type



HF/DC

DOOR CLOSER

Max door width: 500-1000mm
 Material: Aluminium
 Max door weigh: 25-45kg
 Color: white/silver/black

Dimension of appearance

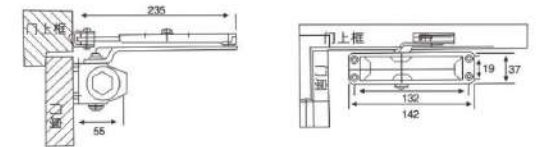

Material: Mirror/Satin
 Finishing: SS304/SS316
 Available for dorma style



DT-65 SET L/R

GLASS DOOR LOCKS

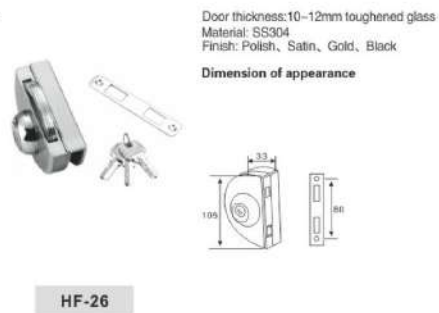
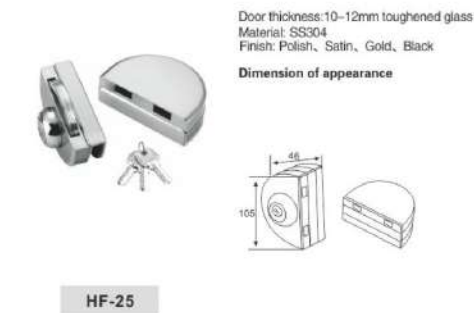
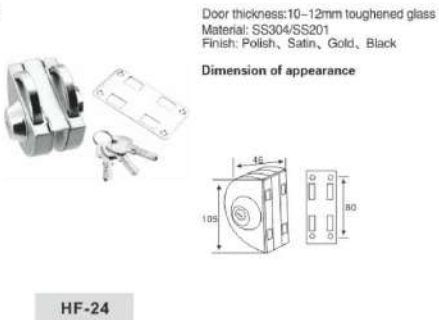
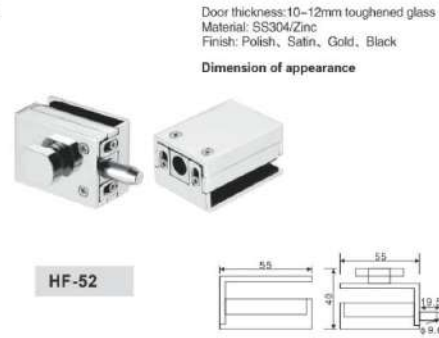
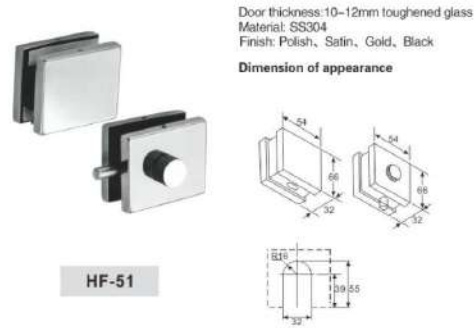

GLASS DOOR LOCKS

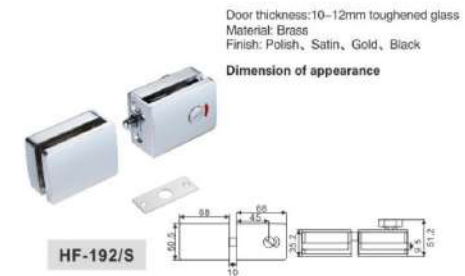
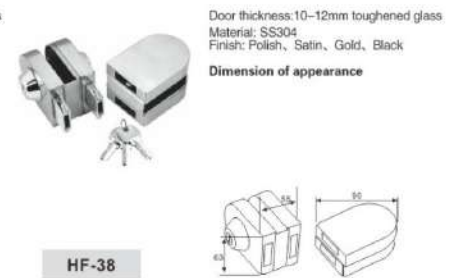
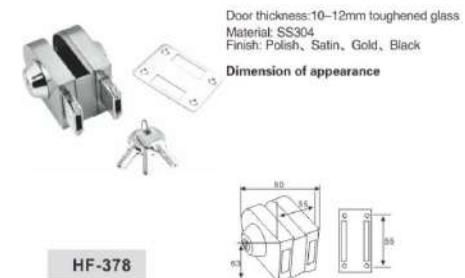
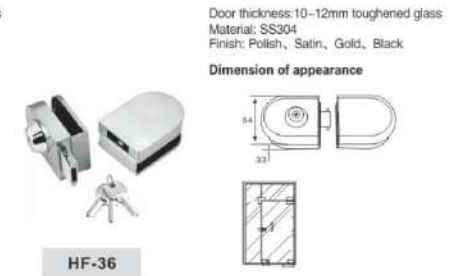
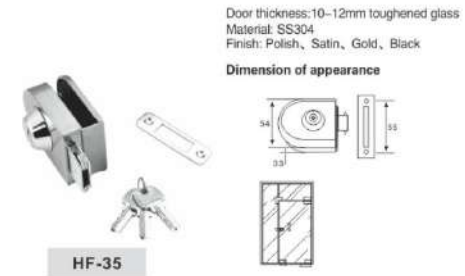

SHOWER FITTINGS



HF-9907

Pipe connector
Materials: SS304/316, Brass
Suitable diameter: $\Phi 19$, $\Phi 22$, $\Phi 25$
Finished: PSS, Gold, Black



HF-9914

Pipe connector
Materials: SS304/316, Brass
Suitable diameter: $\Phi 19$, $\Phi 22$, $\Phi 25$
Finished: PSS, Gold, Black



HF-9915

Pipe connector
Materials: SS304/316, Brass
Suitable diameter: $\Phi 19$, $\Phi 22$, $\Phi 25$
Finished: PSS, Gold, Black



HF-9917

Pipe connector
Materials: SS304/316, Brass
Suitable diameter: $\Phi 19$, $\Phi 22$, $\Phi 25$
Finished: PSS, Gold, Black



HF-9916

Pipe connector
Materials: SS304/316, Brass
Suitable diameter: $\Phi 19$, $\Phi 22$, $\Phi 25$
Finished: PSS, Gold, Black



HF-9913

Pipe connector
Materials: SS304/316, Brass
Suitable diameter: $\Phi 19$, $\Phi 22$, $\Phi 25$
Finished: PSS, Gold, Black



HF-9919/25/SQ

Pipe connector
Materials: SS304/316
Suitable diameter: 25*25
Finished: PSS, Gold, Black



HF-9927/25

Pipe connector
Materials: SS304/316
Suitable diameter: 25*25
Finished: PSS, Gold, Black



HF-9920/25/SQ

Pipe connector
Materials: SS304/316
Suitable diameter: 25*25
Finished: PSS, Gold, Black



HF-9923/25/SQ

Pipe connector
Materials: SS304/316
Suitable diameter: 25*25
Finished: PSS, Gold, Black



HF-9918/25/ZN/4-WAY

Pipe connector
Materials: Zinc alloy
Suitable diameter: $\Phi 25$
Finished: PSS, Gold, Black



HF-9918/25/ZN/3-WAY

Pipe connector
Materials: Zinc alloy
Suitable diameter: $\Phi 25$
Finished: PSS, Gold, Black



HF-9918/25/ZN/4-T

Pipe connector
Materials: Zinc alloy
Suitable diameter: $\Phi 19$
Finished: PSS, Gold, Black

SHOWER FITTINGS



HF-962

Bathroom support rod

Notice: The glass must be tempered



B01 Bathroom support rod



B02 Bathroom support rod

HF-960

Notice: The glass must be tempered



Installation illustration



Bathroom support rod

HF-961

Notice: The glass must be tempered

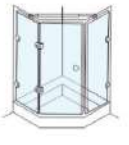

Installation illustration

SHOWER HINGES SERIES



SHOWER HINGES SERIES



HF-11/90

Bevel circinal angle 90° Double side bathroom glass clamp

Finish: Polish, Satin, Gold, Black
Material: Refined Stainless steel(S04/316, Zinc alloy, Brass)
Available for: 8-12mm toughened glass

Dimension of appearance

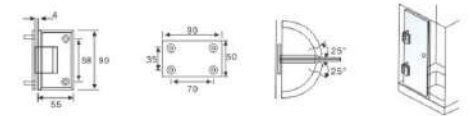

HF-12/135

Camber 135° bathroom glass clamp

Finish: Polish, Satin, Gold, Black
Material: Refined Stainless steel(S04/316, Zinc alloy, Brass)
Available for: 8-12mm toughened glass

Dimension of appearance

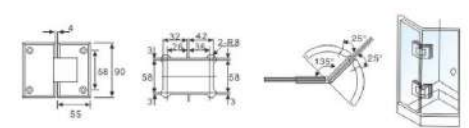

HF-12/180

Bevel circinal angle 180° bathroom glass clamp

Finish: Polish, Satin, Gold, Black
Material: Refined Stainless steel(S04/316, Zinc alloy, Brass)
Available for: 8-12mm toughened glass

Dimension of appearance

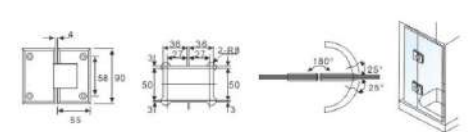

HF-12/90

Bevel circinal angle 90° Double side bathroom glass clamp

Finish: Polish, Satin, Gold, Black
Material: Refined Stainless steel(S04/316, Zinc alloy, Brass)
Available for: 8-12mm toughened glass

Dimension of appearance

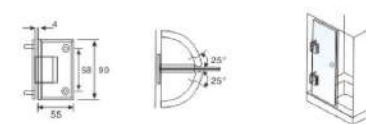

SHOWER HINGES SERIES



HF-21/90

Square 90° Double side bathroom glass clamp

Finish: Polish, Satin, Gold, Black
Material: Refined Stainless steel304/316, Zinc alloy, Brass
Available for: 8-12mm toughened glass

Dimension of appearance

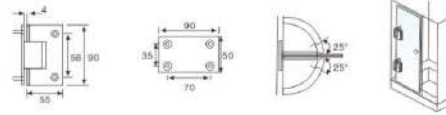

HF-22/90

Straight edge rounded 90° double-page bathroom glass clip

Finish: Polish, Satin, Gold, Black
Material: Refined Stainless steel304/316, Zinc alloy, Brass
Available for: 8-12mm toughened glass

Dimension of appearance

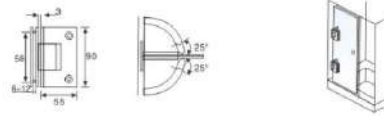

HF-32/180

Square 180° bathroom glass clamp

Finish: Polish, Satin, Gold, Black
Material: Refined Stainless steel304/316, Zinc alloy, Brass
Available for: 8-12mm toughened glass

Dimension of appearance

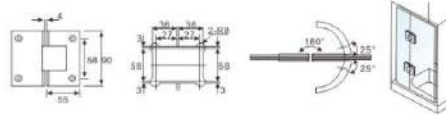

HF-32/90

Square 90° Double opening bathroom glass clamp

Finish: Polish, Satin, Gold, Black
Material: Refined Stainless steel304/316, Zinc alloy, Brass
Available for: 8-12mm toughened glass

Dimension of appearance

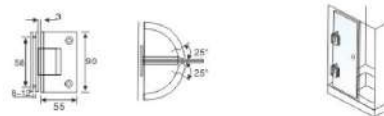

SHOWER HINGES SERIES



HF-21/104

Finish: Polish, Satin, Gold, Black
Material: Refined Stainless steel304/316, Zinc alloy, Brass
Available for: 8-12mm toughened glass

Dimension of appearance

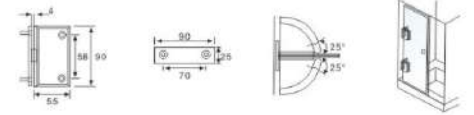

HF-6012(Big) / HF-6012/B(Small)

Finish: Polish, Satin, Gold, Black
Material: Zinc alloy
Available for: 8-12mm toughened glass

Dimension of appearance



HF-51/90

Semi-circular 90° Double side bathroom glass clamp

Finish: Polish, Satin, Gold, Black
Material: Zinc alloy, Brass
Available for: 8-12mm toughened glass

Dimension of appearance

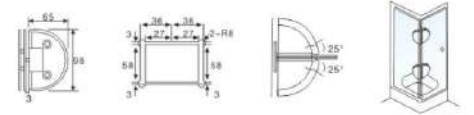

HF-52/180

Semi-circular 180° bathroom glass clamp

Finish: Polish, Satin, Gold, Black
Material: Zinc alloy, Brass
Available for: 8-12mm toughened glass

Dimension of appearance

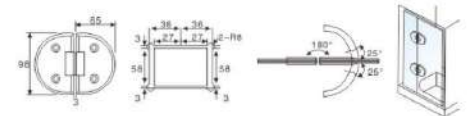

SHOWER HINGES SERIES



HF-851

90° bathroom glass clamp

Finish: Polish, Satin, Gold, Black
Material: Stainless steel, Zinc alloy, Brass
Available for: 8-12mm toughened glass

Dimension of appearance

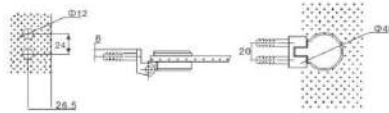

HF-852

180° bathroom glass clamp

Finish: Polish, Satin, Gold, Black
Material: Stainless steel, Zinc alloy, Brass
Available for: 8-12mm toughened glass

Dimension of appearance

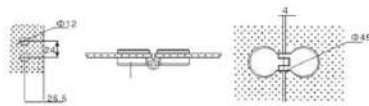

HF-871

90° bathroom glass clamp

Finish: Polish, Satin, Gold, Black
Material: Stainless steel
Available for: 8-12mm toughened glass

Dimension of appearance

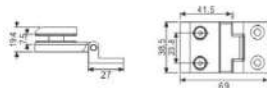

HF-872

180° Double side bathroom glass clamp

Finish: Polish, Satin, Gold, Black
Material: Stainless steel
Available for: 8-12mm toughened glass

Dimension of appearance

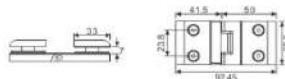

GLASS CONNECTORS



HF-9011

Glass partition brace 0°

Finish: Polish, Satin, Gold, Black
Material: Zinc alloy, Stainless Steel, Brass
Available for: 8-10mm toughened glass

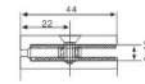

HF-9012

Glass partition brace 90°single

Finish: Polish, Satin, Gold, Black
Material: Zinc alloy, Stainless Steel, Brass
Available for: 8-10mm toughened glass

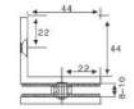

HF-9013

Glass partition brace 180°single

Finish: Polish, Satin, Gold, Black
Material: Zinc alloy, Stainless Steel, Brass
Available for: 8-10mm toughened glass

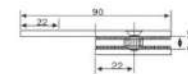

HF-9014

Glass partition brace 90°double

Finish: Polish, Satin, Gold, Black
Material: Zinc alloy, Stainless Steel, Brass
Available for: 8-10mm toughened glass

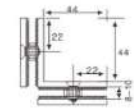

HF-9015

Glass partition brace 135°double

Finish: Polish, Satin, Gold, Black
Material: Zinc alloy, Stainless Steel, Brass
Available for: 8-10mm toughened glass

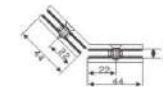

HF-9016

Glass partition brace 180°double

Finish: Polish, Satin, Gold, Black
Material: Zinc alloy, Stainless Steel, Brass
Available for: 8-10mm toughened glass

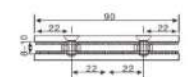

GLASS CONNECTORS



HF-9021

Glass partition brace 0°

Finish: Polish, Satin, Gold, Black
Material: Zinc alloy, Stainless Steel, Brass
Available for: 8-10mm toughened glass

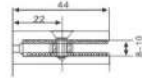

HF-9022

Glass partition brace 90° single

Finish: Polish, Satin, Gold, Black
Material: Zinc alloy, Stainless Steel, Brass
Available for: 8-10mm toughened glass

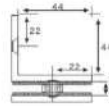

HF-9023

Glass partition brace 180° single

Finish: Polish, Satin, Gold, Black
Material: Zinc alloy, Stainless Steel, Brass
Available for: 8-10mm toughened glass

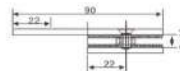

HF-9024

Glass partition brace 90° double

Finish: Polish, Satin, Gold, Black
Material: Zinc alloy, Stainless Steel, Brass
Available for: 8-10mm toughened glass

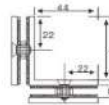

HF-9025

Glass partition brace 135° double

Finish: Polish, Satin, Gold, Black
Material: Zinc alloy, Stainless Steel, Brass
Available for: 8-10mm toughened glass



HF-9026

Glass partition brace 180° double

Finish: Polish, Satin, Gold, Black
Material: Zinc alloy, Stainless Steel, Brass
Available for: 8-10mm toughened glass



GLASS CONNECTORS



HF-151

Glass connector 0°

Finish: Polish, Satin, Gold, Black
Material: Zinc alloy, SS304, Brass
Available for: 8-10mm toughened glass



HF-152

Glass connector (90° two sides)

Finish: Polish, Satin, Gold, Black
Material: Zinc alloy, SS304, Brass
Available for: 8-10mm toughened glass

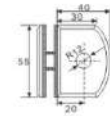

HF-153

Glass connector (90° one sides)

Finish: Polish, Satin, Gold, Black
Material: Zinc alloy, SS304, Brass
Available for: 8-10mm toughened glass

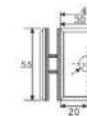

HF-154

Glass connector (135° two sides)

Finish: Polish, Satin, Gold, Black
Material: Zinc alloy, SS304, Brass
Available for: 8-10mm toughened glass

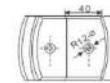

HF-157

Glass connector (180° one sides)

Finish: Polish, Satin, Gold, Black
Material: Zinc alloy, SS304, Brass
Available for: 8-10mm toughened glass

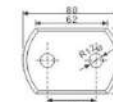

HF-156

Glass connector (180° two sides)

Finish: Polish, Satin, Gold, Black
Material: Zinc alloy, SS304, Brass
Available for: 8-10mm toughened glass

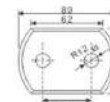

HF-128

T-Style glass connector

Finish: Polish, Satin, Gold, Black
Material: Zinc alloy, Stainless Steel, Brass
Available for: 8-10mm toughened glass

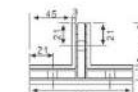

GLASS SHELF HOLDER & CLAMP

Glass clamp

Finish: Polish, Satin
Material: Iron
Available for: 8-10mm toughened glass



HF-2199

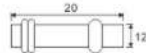

Glass clamp

Finish: Polish, Satin
Material: Zinc alloy
Available for: 8-10mm toughened glass



HF-2198

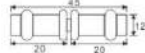

Glass clamp

Finish: Polish, Satin
Material: Iron
Available for: 8-10mm toughened glass



HF-2197



Glass clamp

Finish: Polish, Satin
Material: Iron
Available for: 8-10mm toughened glass



HF-2196

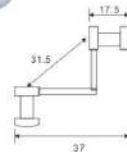

camber glass clamp

Finish: Polish, Satin
Material: Zinc alloy, SS304
Available for: 8-10mm toughened glass



HF-61/R

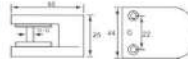

flat glass clamp

Finish: Polish, Satin
Material: Zinc alloy, SS304
Available for: 8-10mm toughened glass



HF-62/F

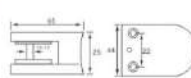

Glass clamp

Finish: Polish, Satin
Material: Zinc alloy
Available for: 8-10mm toughened glass



HF-452

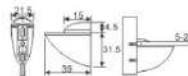

Glass clamp

Finish: Polish, Satin
Material: Zinc alloy
Available for: 8-10mm toughened glass



HF-652

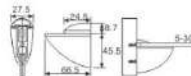

GLASS SHELF HOLDER & CLAMP

Glass clamp

Finish: Polish, Satin
Material: Zinc alloy
Available for: 8-10mm toughened glass



HF-942

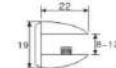

Glass clamp

Finish: Polish, Satin
Material: Zinc alloy
Available for: 8-12mm toughened glass



HF-352



Glass clamp

Finish: Polish, Satin
Material: Zinc alloy
Available for: 8-10mm toughened glass



HF-492

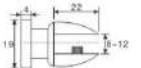

Glass clamp

Finish: Polish, Satin
Material: Zinc alloy
Available for: 8-12mm toughened glass



HF-532

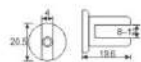

Glass clamp

Finish: Polish, Satin
Material: Zinc alloy
Available for: 8-10mm toughened glass



HF-502



Glass clamp

Finish: Polish, Satin
Material: Zinc alloy
Available for: 8-12mm toughened glass



HF-235

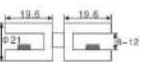

Glass clamp

Finish: Black/ Silver
Material: Aluminum
Available for: 8-12mm toughened glass



HF-A270

Glass clamp

Finish: Black/ Silver
Material: Aluminum
Available for: 8-12mm toughened glass



HF-A269

Glass clamp

Finish: Black/ Silver
Material: Aluminum
Available for: 8-12mm toughened glass



HF-A268

Glass clamp

Finish: Polish, Satin
Material: Zinc alloy, SS304, Brass
Available for: 8-12mm toughened glass



HF-215

Glass clamp

Finish: Polish, Satin
Material: Zinc alloy, SS304, Brass
Available for: 8-12mm toughened glass



HF-232

Glass clamp

Finish: Polish, Satin
Material: Zinc alloy, SS304, Brass
Available for: 8-12mm toughened glass



HF-843

Glass clamp

Finish: Polish, Satin
Material: Zinc alloy, SS304, Brass
Available for: 8-12mm toughened glass



HF-842

SLIDING SYSTEM



SLIDING SYSTEM

SDS-SET 01

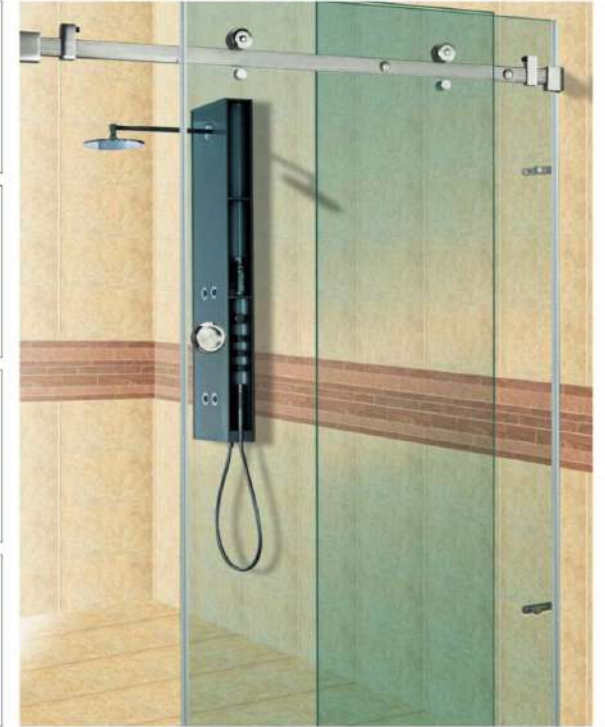

Above application is just for reference, will be changed according to the actual scene.

30x10 installation of square pipe with jumping-proof pillar

30x10 sectional installation of square pipe with jumping-proof pillar

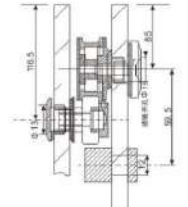
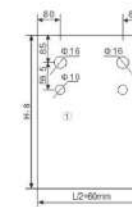
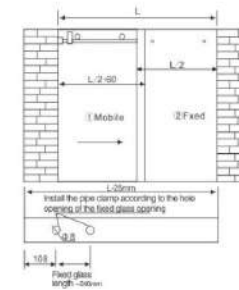

SLIDING ACCESSORIES



HF-01

Glass door hanging wheel
 Finish: Satin, Polish
 Material: Stainless steel
 Available for: All kinds of glass sliding doors
 Weight bearing: 100kg/8 wheels/90kg/4 wheels

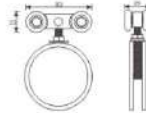

HF-05

Glass hanging wheel
 Finish: Satin, Polish
 Material: Stainless steel
 Available for: All kinds of glass sliding doors
 Max door weight: 120kg
 Matching 4 wheels (max door weight: 100kg)

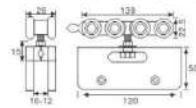

SDS-S 430A/F

Clamp fixing for track
 Material: Stainless steel
 Diameter: $\varnothing 19/\varnothing 25$

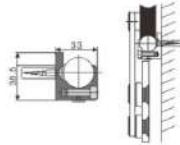

SDS-S 430W

Clamp fixing for track
 Material: Stainless steel
 Diameter: $\varnothing 19/\varnothing 25$

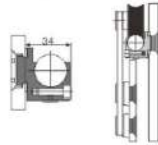

SDS-S 461

Endpiece
 Material: Stainless steel
 Diameter: $\varnothing 19/\varnothing 25$



SDS-S 422/22MM



SDS-S 450SSS2

Floor guide
 Material: Stainless steel
 Diameter: $\varnothing 25$



SDS-S 420A/L/R

Door stop
 Material: Stainless steel
 Diameter: $\varnothing 25$



SDS-S 410 D

Glass hanging wheel
 Material: Stainless steel
 The glass maximum weight 150kg

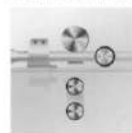

RSR-CY6000

Glass door hanging rail
 Finish: Satin, Polish
 Material: Aluminum
 Available for: All kinds of glass sliding doors
 Weight bearing: 100kg/8 wheels; 50kg/4 wheels

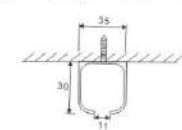

RSR-CY3000

Glass door hanging rail
 Finish: Satin, Polish
 Material: Aluminum
 Available for: All kinds of glass sliding doors
 Weight bearing: 100kg/8 wheels; 50kg/4 wheels



HF-SDSCY05

Door stop
 Material: Stainless steel
 Diameter: $\varnothing 19, \varnothing 25$

SLIDING ACCESSORIES



HF-312

Bathroom Glass Door Handle
 Finish: Polish, Satin
 Material: Stainless steel, Brass

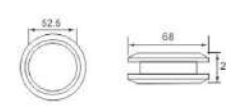

HF-840

Ceiling to glass fixed point connector CS
 Material: Stainless steel
 Connector for connecting wall and glass, just one sides can adjusted angle



SDS-S 810



SDS-S 830



SDS-S 812



SDS-S 820

Connecting rod

Angle	Length connecting rod and in mm			
	52.5	60	85	103
A/B	A/B	A/B	A/B	A/B
90°	75.6	81	96.5	111.3
95°	60.2	65.3	80.5	94.8
100°	55.7	61.6	75.9	89.5
105°	53.4	58.2	72.1	85.3
110°	50.5	55.1	68.5	81.3
115°	47.6	51.8	65.3	77.7
120°	45.3	49.5	62.3	74.4
125°	42.8	47.1	59.5	71.4
130°	40.7	44.9	57	68.6
135°	38.7	42.8	54.7	66
180°	24.7	28.5	39.5	50



SDS-S 850/A



SDS-S 850/B

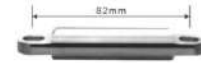

SDS-S 850/C



SDS-S 850/D



SDS-S 510/A

Fixed glass and wall
 Adjustable single point fixing CS
 Adjustable, adjustable 8.5-10.5mm



SDS-S 510/B

Fixed glass and wall
 Adjustable single point fixing CS
 Adjustable, adjustable 12.5mm-14.5mm

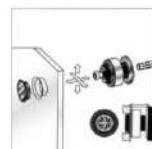

SLIDING ACCESSORIES & SPACER



SDS-S510/C

Fixed glass and wall

Adjustable single point fixing CS
Adjustable adjustable 14mm-18mm

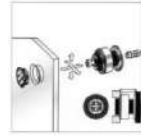

SDS-S510/D

Fixed glass and wall

Adjustable single point fixing CS
Adjustable adjustable 18mm-22mm

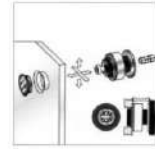

SDS-S510/E

Fixed glass and wall

Adjustable single point fixing CS
Adjustable adjustable 22mm-26mm

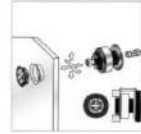

HF-310

Bathroom Glass Door Handle

Finish: Polish, Satin
Material: Stainless steel, Brass

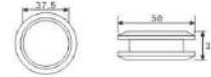

HF-002(S)4030/BOLT/304

Stainless steel Spacer series
Material: Stainless steel
Finish: PSS, SSs, Gold, Black

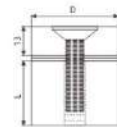

B \ L	20	25	30	40	50	60	70	80	100
Ø19	20	25	30	40	50	60	70	80	100
Ø25	20	25	30	40	50	60	70	80	100
Ø30	20	25	30	40	50	60	70	80	100
Ø40	20	25	30	40	50	60	70	80	100
Ø50	20	25	30	40	50	60	70	80	100



HF-003(S)5040/S

Stainless steel Spacer series
Material: Stainless steel
Finish: PSS, SSs, Gold, Black

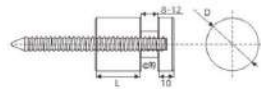

B \ L	20	25	30	40	50	60	70	80	100
Ø19	20	25	30	40	50	60	70	80	100
Ø25	20	25	30	40	50	60	70	80	100
Ø30	20	25	30	40	50	60	70	80	100
Ø40	20	25	30	40	50	60	70	80	100
Ø50	20	25	30	40	50	60	70	80	100



HF-002/3050

Stainless steel Spacer series
Material: Stainless steel
Finish: PSS, SSs, Gold, Black

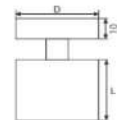

Solid/Hollow

B \ L	20	25	30	40	50	60	70	80	100
Ø12	22	25	30	40	50	60	70	80	100
Ø16	20	25	30	40	50	60	70	80	100
Ø19	20	25	30	40	50	60	70	80	100
Ø25	20	25	30	40	50	60	70	80	100
Ø30	20	25	30	40	50	60	70	80	100
Ø40	20	25	30	40	50	60	70	80	100
Ø50	20	25	30	40	50	60	70	80	100

DOOR KNOBS



HF-3001

Materials: Stainless steel, Brass, Aluminum
Finish: Polish, Satin



HF-3004

Materials: Stainless steel, Brass, Aluminum
Finish: Polish, Satin



HF-3008

Materials: Stainless steel, Brass, Aluminum
Finish: Polish, Satin



HF-3003

Materials: Stainless steel, Brass, Aluminum
Finish: Polish, Satin

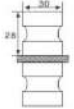

HF-3026

Materials: Stainless steel, Brass, Aluminum
Finish: Polish, Satin



HF-3017

Materials: Stainless steel, Brass, Aluminum
Finish: Polish, Satin

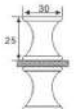

LIP SEALS



HF-001

Glass door waterproof strip
For . 8, 10, 12mm glass



HF-002

Glass door waterproof strip
For . 8, 10, 12mm glass



HF-003

Glass door waterproof strip
For . 8, 10, 12mm glass

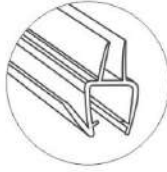

HF-004

Glass door waterproof strip
For . 8, 10, 12mm glass

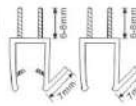

HF-005

Glass door waterproof strip
For . 8, 10, 12mm glass

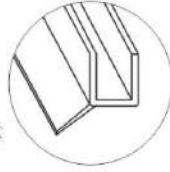

HF-008

Glass door magnetic strip
For . 8, 10, 12mm glass

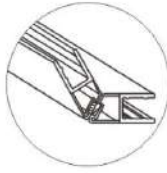

HF-010

Glass door magnetic strip
For . 8, 10, 12mm glass

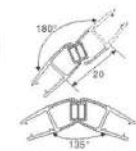

HF-011

Glass door waterproof strip
For 8, 10, 12mm glass

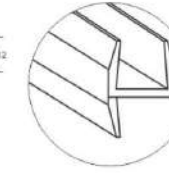
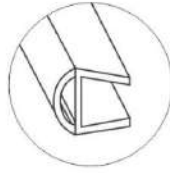

HF-012

Glass door waterproof strip
For 8, 10, 12mm glass

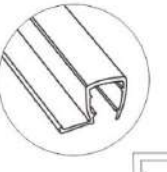

HF-014

Glass door waterproof strip
For . 8, 10, 12mm glass

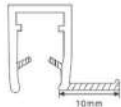

HF-015

Glass door waterproof strip
For . 8, 10, 12mm glass

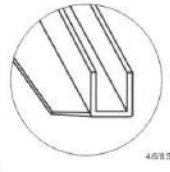
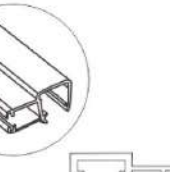

HF-020

Glass door waterproof strip
For . 8, 10, 12mm glass

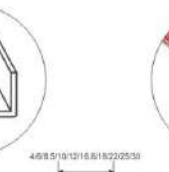

HF-022-10MM

Glass door waterproof strip
For . 10mm glass

FOLDING DOOR ACCESSORIES



HF-8700-SET



HF8700A-16

Upper clip

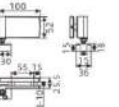

HF8700A-6

Folding hinge

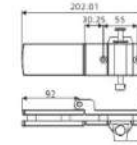

HF8700A-10

Folding hinge with pulley

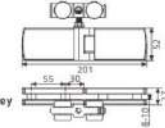

HF8700A-11

Wheeled glass clip

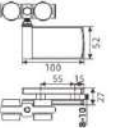

HF8700A-17

Lower fixing clip

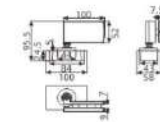

HF8700A-13

Folding hinge with pin

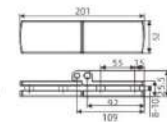

HF8700A-12

Lower guide folding hinge

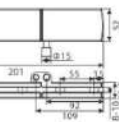

HF8700A-14

Lower guide glass clamp

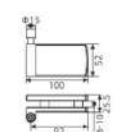

HF8700A-1

Guide rail ZDM09



HF8700A-15

Lower guide slot

GLASS DOOR HANDLES



HF-626

Materials: SS316, SS304, SS201
Finish: Polish, Satin, Titanium
Pipe diameter = A, Hole distance = B

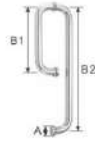

Size parameters

A	φ19	φ19	φ25	φ25	φ25
B1	200	200	175	200	200
B2	400	450	425	400	450



HF-633

Materials: SS316, SS304, SS201
Finish: Polish, Satin, Titanium
Pipe diameter = A, Hole distance = B, Length = C



Size parameters

A	φ25	φ25	φ32	φ32	φ32	φ38
B	300	400	800	900	1000	1500
C	450	600	1000	1200	1500	2000

GLASS DOOR HANDLES



HF-629

Materials: SS316, SS304, SS201
Finish: Polish, Satin, Titanium
Pipe diameter = A, Hole distance = B



Size parameters

A	φ25	φ32
B	305	305



HF-621

Materials: SS316, SS304, SS201
Finish: Polish, Satin, Titanium
Pipe diameter = A, Hole distance = B



Size parameters

A	φ19	φ19	φ19	φ25	φ25	φ25
B	400	450	600	400	450	600



HF-233

Materials: SS316, SS304, SS201
Finish: Polish, Satin, Titanium
Pipe diameter = A, Hole distance = B, Length = C

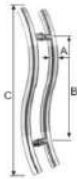

Size parameters

A	φ32	φ32
B	305	400
C	450	600



HF-628

Materials: SS316, SS304, SS201
Finish: Polish, Satin, Titanium
Pipe diameter = A, Hole distance = B, Length = C

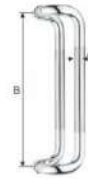

Size parameters

A	φ32	φ32	φ32
B	305	450	600



HF-334

Materials: SS316, SS304, SS201
Finish: Polish, Satin, Titanium
Pipe diameter = A, Hole distance = B, Length = C

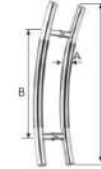

Size parameters

A	φ32	φ32
B	305	400
C	450	600



HF-620

Materials: SS316, SS304, SS201
Finish: Polish, Satin, Titanium
Pipe diameter = A, Hole distance = B



Size parameters

A	25x13	38x25	38x25	38x25	38x25
B	450	600	800	1000	1200

GLASS DOOR HANDLES



HF-626/SQ/E

Materials: SS316, SS304, SS201
Finish: Polish, Satin, Titanium
Pipe diameter = A, Hole distance = B

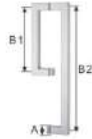

Size parameters

A	25x25	25x25
B1	200	250
B2	400	450



633/SQ/B

Materials: SS316, SS304, SS201
Finish: Polish, Satin, Titanium
Pipe diameter = A, Hole distance = B, Length = C

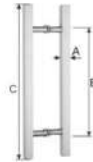

Size parameters

A	25X25	25X13	38X25	38X25	38X25	38X25
B	305	305	400	600	800	900
C	450	450	600	800	1000	1200



HF-633/DV

Materials: SS316, SS304, SS201
Finish: Polish, Satin, Titanium
Pipe diameter = A, Hole distance = B, Length = C

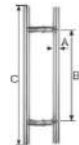

Size parameters

A	φ32	φ32	φ32	φ32
B	305	400	600	800
C	450	600	800	1200



HF-627

Materials: SS316, SS304, SS201
Finish: Polish, Satin, Titanium
Pipe diameter = A, Hole distance = B



Size parameters

A	φ19	φ19	φ25	φ25	φ25	φ25	φ32	φ32
B	150	200	200	250	305	450	305	450

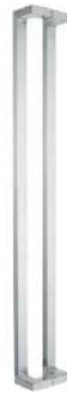

HF-634

Materials: SS316, SS304, SS201
Finish: Polish, Satin, Titanium
Pipe diameter = A, Hole distance = B



Size parameters

A	25X25	25X25	25X38	25X38
B	450	600	800	1000

SPIDER FITTINGS

HF-200X

Material: Ss304/316
Finish: Pas/sas
Glass Thickness: 12-16mm

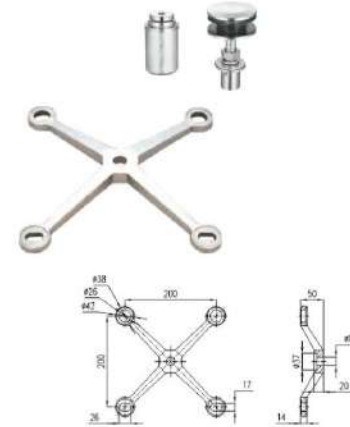

HF-200V

Material: Ss304/316
Finish: Pas/sas
Glass Thickness: 12-16mm



HF-200L

Material: Ss304/316
Finish: Pas/sas
Glass Thickness: 12-16mm



HF-200 1/2

Material: Ss304/316
Finish: Pas/sas
Glass Thickness: 12-16mm



SPIDER FITTINGS

HF-LZ200X

Material: Ss304/316
Finish: Pass/Pass
Glass Thickness: 12-16mm

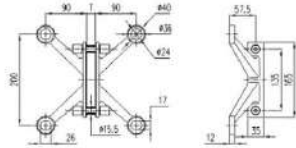

HF-LZ200L

Material: Ss304/316
Finish: Pass/Pass
Glass Thickness: 12-16mm

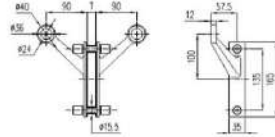

HF-LZ200 V

Material: Ss304/316
Finish: Pass/Pass
Glass Thickness: 12-16mm

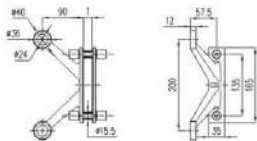

HF-LZ90

Material: Ss304/316
Finish: Pass/Pass
Glass Thickness: 12-16mm

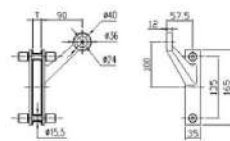

GOLD SERIES

HF-84/GOLD



HF-65/D/GOLD



HF-11/90/GOLD



HF-12/180/GOLD



HF-10 D/GOLD



HF-20/GOLD



HF-30/GOLD



HF-30K/GOLD



HF-50 S/R GOLD



HF-50 S/CL/GOLD



HF-40/GOLD



HF-40K/GOLD



HF-9001/GOLD



HF-9915/25/PSS/GOLD



HF-9914/25/PSS/GOLD



HF-9907/25/PSS/GOLD



HF-34/R/GOLD



HF-9011/B/GOLD



HF-9012/B/GOLD



HF-9014/B/GOLD



HF-9015/B/GOLD



HF-9016/B/GOLD



GOLD SERIES

HF-633/B/GOLD

Materials: SS316, SS304, SS201
Finish: Polish, Satin, Titanium



HF-626/D/GOLD

Materials: SS316, SS304, SS201
Finish: Polish, Satin, Titanium



Square tube 30x10

Materials: SS316, SS304, SS201
Finish: Polish, Satin, Titanium



SDS-S/MANETSET B/PSS/GOLD

Standard Application

Finishing: Polish, Satin, Gold

Door thickness: 10-12mm toughened glass
Material: SS304, Aluminum alloy
Finishing: Polish, Satin, Gold, Black



HF015-1-2



HF015-2-4



HF015-3-1 Left



HF015-4-1 right



HF015-5-1



HF015-6-2



HF015-7-1



HF015-8-1

SDS-S/SET 01/GOLD

Standard Application



HF002-1-2



HF002-2-2



HF002-3-2



HF002-4-2



HF002-5-2



HF002-6-1



HF002-7-1(Optional)



HF002-8-1 10x30 Tube

BLACK SERIES

HF-84/BLACK



HF-65/D/BLACK



HF-11/90/SSP/BLACK



HF-12/180/SSP/BLACK



HF-10 D/BLACK



HF-20/BLACK



HF-30/BLACK



HF-30K/BLACK



HF-50 S/R/BLACK



HF-50 S/CL/BLACK



HF-40/BLACK



HF-40K/BLACK



HF-9001/BLACK



HF-9915/25/PSS/BLACK



HF-9914/25/PSS/BLACK



HF-9907/25/PSS/BLACK



HF-34/BLACK



HF-9011/B/BLACK



HF-9012/B/BLACK



HF-9014/B/BLACK



HF-9015/B/BLACK



HF-9016/B/BLACK



BLACK SERIES

HF-634F

Materials: SS316, SS304, SS201
Finish: Polish, Satin, Titanium



HF-633/B/BLACK

Materials: SS316, SS304, SS201
Finish: Polish, Satin, Titanium



HF-626/D/BLACK

Materials: SS316, SS304, SS201
Finish: Polish, Satin, Titanium



Square tube 30x10

Materials: SS316, SS304, SS201
Finish: Polish, Satin, Titanium



SDS-S/MANETSET B/PSS Black

Standard Application



SDS-S/SET 01/Black

Standard Application



HANDRAIL FITTINGS

Handrail Fittings



Material: Stainless Steel Grades 304/316 Finish: Mirror, Satin & Coloured

HANDRAIL FITTINGS

As the region's largest solution provider in stainless steel and allied metal products and solutions for architectural applications, we specialize in design, process, manufacture and supply of Handrail Equipment and accessories. Made from high quality 304 and 316 Stainless Steel, our products are sound and sustainable. Our manufacturing capacity includes Pipe Bend Elbows, Wall Holding, Ground Holding, End Caps, Pipe/ Rod Connectors, Pipe Fittings to name a few. Marketed under brand name H-Fit, our products are distributed/retailed across GCC, Middle East, South East Asia through our offices and strategic retail network.

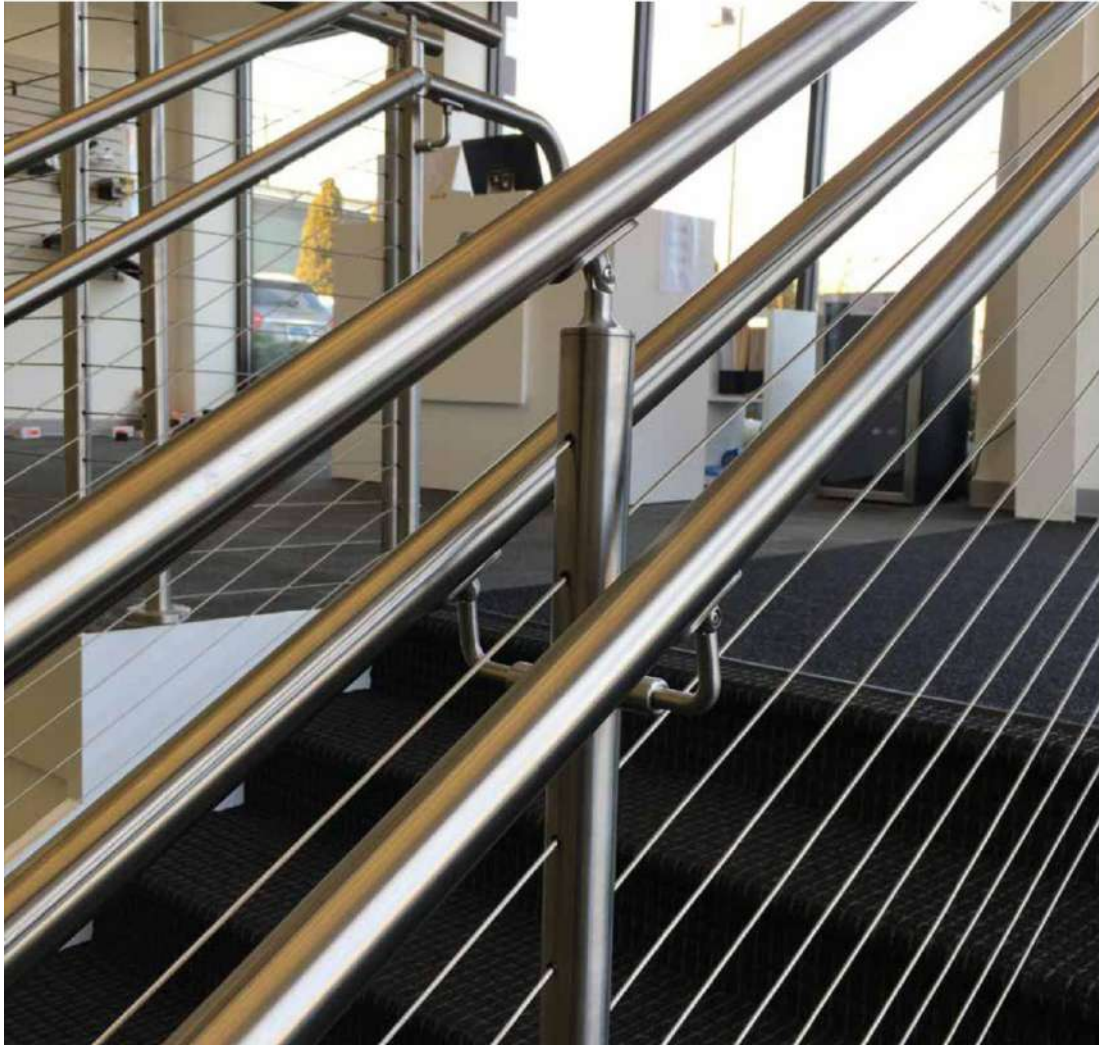

HANDRAIL FITTINGS

CONNECTING Pipe Bend Elbows



SS Elbow Long Radius



SS Elbow Short Radius Casted



SS Elbow Sharp Bend

WALL HOLDING Brackets/ Posts



Wall Bracket Sharp Bend



Wall To Pipe Bracket Round



Wall To Pipe Bracket With Cover



Glass To Pipe Bracket



Glass To Pipe Bracket Adjustable



Round Central Post



Round End Post

END CAPS



Dome End Cap



Flat End Cap



Convex End Cap

GROUND HOLDING (Base Plate, Covers, Saddle, Flanges)



SS Base Plate



Round Edge Base Plate Cover



Flat Edge Base Plate Cover



Step Type Base Plate Cover



Tooth Flange



Circular Flange



Saddle Ball Clamp

PIPE/ ROD CONNECTORS



SS Rod Connector



3 Way Pipe Connector



INLINE CONNECTOR



Pipe To Pipe Connector Adjustable

SPIGOT



Spigot Round Type



Spigot Square Type

HANDRAIL FITTINGS

GLASS FIXERS (Brackets / Glass Clips)



D Type Glass Bracket



Square Round Glass Bracket



Square Flat Glass Bracket





THANK YOU

Contact us:

info@homeharmony.ae

[+971 54 330 8707](tel:+971543308707)

www.hhmetal.ae

