



Main Gates



Pergola/Shading



Motorized System



Louvers

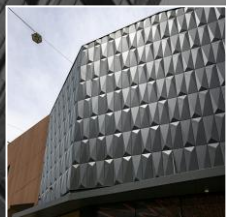

Aluminium Cladding



Mashrabiya



Fences



Motorized Gates



Balustrade



Railing



Fly Screens



Facade & Ceiling

ABOUT THIS PROFILE



This company profile provides an overview of **HH-Metal**, a metal solutions company with a commitment to quality, reliability, and innovation. The profile has been created to introduce our company, outline our capabilities, and share the values that guide our operations.

HH-Metal was established to serve the growing demand for dependable, complete metal solutions and related services. Since our founding, we have focused on delivering strong, precise, and cost-effective metal products that meet the needs of residential, commercial, and custom projects. Our approach combines modern technology, skilled workmanship, and strict quality control to ensure consistent results.

This profile highlights our dedication to customer satisfaction, safety, and continuous improvement. It reflects our mission to foster long-term partnerships built on trust, transparency, and performance. Every project we undertake is handled with attention to detail and a commitment to meeting client expectations.

As a growing company, **HH-Metal** remains focused on expanding our capabilities while maintaining the core values that define us. This profile serves as a reference for our clients, partners, and stakeholders to better understand who we are, what we do, and the standards we stand for.

ISO CERTIFIED COMPANY

HH-Metal is proud to be an ISO Certified Company, reflecting our strong commitment to maintaining internationally recognized standards of quality, safety, and operational excellence. Our certification ensures that all our processes from material selection and fabrication to installation and final delivery are carefully planned, systematically monitored, and continuously improved.

By following ISO standards, we ensure consistency, reliability, and efficiency in every project we undertake. This not only enhances the quality of our products and services but also reinforces our dedication to customer satisfaction, workplace safety, and sustainable business practices. Our ISO certification stands as a testament to our professionalism, attention to detail, and ongoing pursuit of excellence.





CERTIFICATE

This is to Certify that the Management System of

HOME HARMONY METAL BLACKSMITHING AND ALUMINIUM WORKS

Plot Number 190, Block 2, Unit Number 17, Al Etihad Street,
Umm Dearaa Area, Umm AL Quwain,
United Arab Emirates

has been audited and found to comply with the requirements of:

ISO 9001:2015 (Quality Management System)

For the Scope of activities described below:

Design, Production, and In-situ Installations of Metal and Iron Works, Smithery, Welding, and Aluminum & Glass Systems

Certificate No.: AE260404004

<u>Date of initial registration</u>	<u>Date of this Certificate</u>	<u>Surs. audit on or before/ Certificate expiry</u>	<u>Recertification Due</u>
04 April 2026	04 April 2026	03 April 2027	03 April 2029

Validity of this certificate is subject to successful completion of surveillance audit on or before due date, in case surveillance audit not conducted this certificate shall be suspended/cancelled.





Director

For verification and updated information concerning the present certificate visit to www.lmscert.uk
This certificate is property of LMS Assessments Limited and remains valid subject to satisfactory surveillance audits and shall be returned immediately when demanded.

Accreditation



LMS Assessments Limited
International Office: Barlie House, Oxford Court, Manchester, M2 3WQ(United Kingdom) Phone : +44-161394 1117
(Company Regd. No. 11029176 Registered in England and Wales)
LMS Assessment Services Private Limited
Corporate Office: T1-14, 15 Aarabi arcade, Sector 16, Munshi Pullya, Indira Nagar, Lucknow - 16, India Phone : +91 955 464 5464
Visit -> www.lmscert.uk/www.lmscert.com
E-mail -> info@lmscert.uk



LMS-FM-109/REV04



Thorough Examination Certificate For Welding Machine

Company Name:	Home Harmony Interior Design	Contact Person	Mohamed	Contact Number	0509948265
Project Name	Discovery Dunes , Station 1	Location	Discovery Dunes , Dubai South	Inspector name	Sadam Hussain
Inspection Item	Welding Machine	Date Of Inspection	2025-10-21	Date Of Expiry	2026-10-20
Certificate Number	BSS-231659	Date of issue	2025-10-23	Type of Inspection	Periodic Inspection
Test Report NO.	BsTS-111915	Revision	1	Workorder	63825
Status	Safe				
Welding machine-Description					
Manufacture	AFRA	model	MMA-250	Year of manufacture/origin	2023 / Japan
Type of welding (TIG,ARC,MIG...)	ARC	Additional information	230 V	NDT (report number/test method)	NA
Quantity	1	Identification number	SA3268238161	Previous inspection date	NA
Inspection equipments	DMM15	References	BS EN IEC 60974-4 - 2016		
Defects					
Defect Description	NIL				

All the inspection results relate exclusively to the work ordered or the objects or lot inspected, and the inspection certificate/report shall not be reproduced except in full without the approval of the inspection body and the client. B SAFE has legal indemnity against all losses, accidents, and damages on site arising due to faulty inspection activities during the work. We certify on behalf of B SAFE SAFETY & SECURITY CONSULTANCY that the item(s)/equipment described in the certificate/report is/are

SAFE TO USE

and that the particular details are correct.
B Safe is a third party inspection Type A Inspection Body.

The item(s)/equipment should be re-tested in case of any major repair and/or alteration at the above details/description.
Please note that the below signature and stamping are generated and approved electronically.

Inspection Engineer
ENG. Sadam Hussain



Technical Manager
ENG. Sheik Abdul Kader

ENG-CR-50/ ISSUE 2/ V2/ 2023-10-30

Tel : +971 4 320 94 94 FAX: +971 4 320 94 95 P.O.BOX : 300465 DUBAI - UAE
E MAIL : hb@bssafety.com DUBAI SILICON OASIS - PALACE TOWER 1

www.bssafety.com

BSS-231659 | Page 1 of 3



Thorough Examination Certificate For Cutting Machine

Company Name:	Home Harmony Interior Design	Contact Person	Mohamed	Contact Number	0509948265
Project Name	Discovery Dunes , Station 1	Location	Discovery Dunes , Dubai South	Inspector name	Sadam Hussain
Inspection Item	Bench Cutting Machine	Date Of Inspection	2025-10-21	Date Of Expiry	2026-10-20
Certificate Number	BSS-231661	Date of issue	2025-10-23	Type of Inspection	Periodic Inspection
Test Report NO.	BsTS-111891	Revision	1	Workorder	63825
Status	Safe				
Cutting machine-Description					
Manufacture	GEPAS	Model	GC32000-340	Identification Number	TSH00F22E00227
specification	230 V, 50 Hz & 2000 W	NDT (if any)	NA	Environmental condition	Good
additional information	NIL	Sub-contractor	Jasim Aluminium	Previous inspection date	Not Available
Inspection equipment's	DMM15	References	PUMER1998		
Defects					
Defect Description	NIL				

All the inspection results relate exclusively to the work ordered or the objects or lot inspected, and the inspection certificate/report shall not be reproduced except in full without the approval of the inspection body and the client. B SAFE has legal indemnity against all losses, accidents, and damages on site arising due to faulty inspection activities during the work. We certify on behalf of B SAFE SAFETY & SECURITY CONSULTANCY that the item(s)/equipment described in the certificate/report is/are

SAFE TO USE

and that the particular details are correct.
B Safe is a third party inspection Type A Inspection Body.

The item(s)/equipment should be re-tested in case of any major repair and/or alteration at the above details/description.
Please note that the below signature and stamping are generated and approved electronically.

Inspection Engineer
ENG. Sadam Hussain



Technical Manager
ENG. Sheik Abdul Kader

ENG-CR-65/ ISSUE 2/ V2/ 2023-10-30

Tel : +971 4 320 94 94 FAX: +971 4 320 94 95 P.O.BOX : 300465 DUBAI - UAE
E MAIL : hb@bssafety.com DUBAI SILICON OASIS - PALACE TOWER 1

www.bssafety.com

BSS-231661 | Page 1 of 3



URBAN SAFETY & HEALTH CONSULTANCY



URBAN SAFETY & HEALTH CONSULTANCY
INSPECTION- TRAINING- CONSULTANTS

CERTIFICATE





NAME: VIJAY KUMAR MAHIMAIDDOSS
NATIONALITY: INDIA
UAE ID: 784-1986-7815975-1
COMPANY NAME: HOME HARMONY INTERIOR DESIGN L.L.C

HAS SUCCESSFULLY COMPLETED SAFETY TRAINING COURSE FOR WELDER

USHC WO NO: USHC-WO-3123 **ISSUE DATE:** 17/10/2025
CERTIFICATE NO: USHC-TRC-11676 **EXPIRY DATE:** 16-10-2026

APPROVED BY:
ENG. Hadi Nakad



MOB : +971 50 435 2171 , ABU DHABI - UAE
Email: info@urbansafetygroup.com AL MUSSAFAH M-44 - SALIENT FIDELITY REAL ESTATE L.L.C. BUILDING
www.urbansafetygroup.com

URBAN SAFETY & HEALTH CONSULTANCY



URBAN SAFETY & HEALTH CONSULTANCY
INSPECTION- TRAINING- CONSULTANTS

CERTIFICATE





NAME: SATYENDRA KUMAR SUDAMA PRASAD
NATIONALITY: INDIA
UAE ID: 784-1991-4309535-6
COMPANY NAME: HOME HARMONY INTERIOR DESIGN L.L.C

HAS SUCCESSFULLY COMPLETED SAFETY TRAINING COURSE FOR WELDER

USHC WO NO: USHC-WO-3123 **ISSUE DATE:** 17/10/2025
CERTIFICATE NO: USHC-TRC-11675 **EXPIRY DATE:** 16-10-2026

APPROVED BY:
ENG. Hadi Nakad



MOB : +971 50 435 2171 , ABU DHABI - UAE
Email: info@urbansafetygroup.com AL MUSSAFAH M-44 - SALIENT FIDELITY REAL ESTATE L.L.C. BUILDING
www.urbansafetygroup.com

AGENDA

01

About our company

Deliver high-quality metal solutions built on strength, precision, and reliability.

02

What we do

Specialize in Metal services, offering durable and efficient solutions for residential and commercial.

03

Our projects

Completed many residential and commercial projects in the UAE and is currently engaged in several ongoing projects.

04

Our contact & location

Head office is located in Dubai, with our manufacturing factory based in Umm Al Quwain, U.A.E.



ABOUT US

HH-Metal was founded with a clear vision: to deliver high-quality metal solutions built on strength, precision, and reliability. From the beginning, HH-Metal has focused on combining modern manufacturing techniques with skilled craftsmanship to meet the evolving needs of our clients.

Driven by innovation and continuous improvement, **HH-Metal** is committed to building long-term partnerships and contributing to strong, sustainable infrastructure. As we grow, we remain dedicated to excellence, integrity, and delivering metal solutions you can trust.



01

ABOUT OUR COMPANY

Premium custom metal solutions for residential and commercial projects.



HOME HARMONY
METAL

BLACKSMITHING AND ALUMINIUM WORKS



050-8319882

info@homeharmony.ae

هوم هارموني
ميتال

للعمال الحدادة و الالمبيوم

OUR SERVICES

01

Custom Metal

Bespoke metal solutions tailored to unique designs and requirements.

02

Structural Steel

Strong and reliable steel solutions for residential and commercial projects.

03

Stainless Steel

Precision-crafted stainless steel solutions with high-quality finishes.

04

Aluminum Metal

Lightweight, durable aluminum solutions for modern applications.

05

Architectural Metal

Decorative and functional metal elements enhance architectural designs.

06

Metal Installation

Expert on-site installation ensuring safety, accuracy, and performance.

OUR PHILOSOPHY



Mission

To deliver high-quality metal solutions with reliability and precision.



Vision

To be a trusted metal solutions provider in the UAE.



Values

Quality, integrity, safety, and customer satisfaction.



We provide reliable and custom metal services for a wide range of residential and commercial projects across the UAE.



02

WHAT WE DO

Deliver high-end, tailor-made metal services for residential and commercial developments.



OUR PRODUCTS & SPECIALITIES

➔ DOORS & WINDOWS

➔ PERGOLAS & SHADES

➔ BALUSTRADE/RAILINGS

➔ GATES & FENCING

➔ CLADDING SYSTEM

➔ MAIN ENTRANCE DOORS

➔ FLY SCREENS

➔ SHADING SYSTEM

➔ FALSE CEILING

➔ MASHRABIYA & LOUVERS

➔ METAL WIRE MESH

➔ GALVANIZED IRON

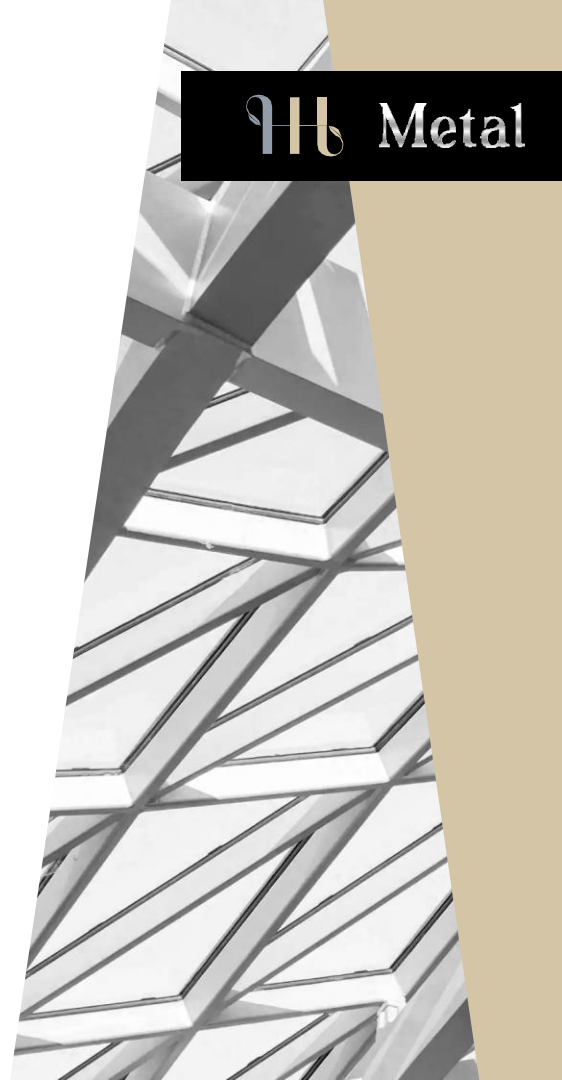

OUR PRODUCTS SUMMARY



Main Gates



Cladding



Louvers



Mashrabiya

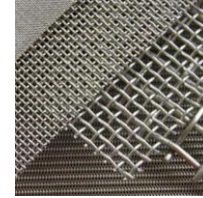

Metal Mesh



Facade & Ceilings



Motorized Louvers



Motorized Screens



Fences



Creative Balustrades



Vertical System



Decorative Metal

HH Metal

PERGOLAS



GATES/FENCING & CLADDING

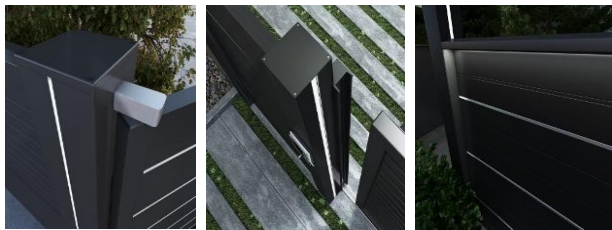
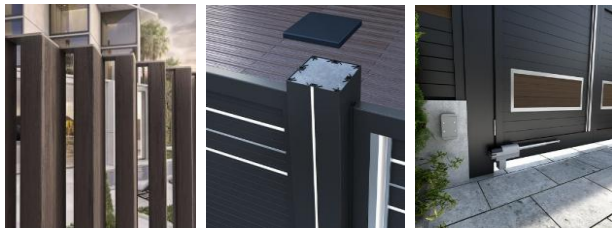

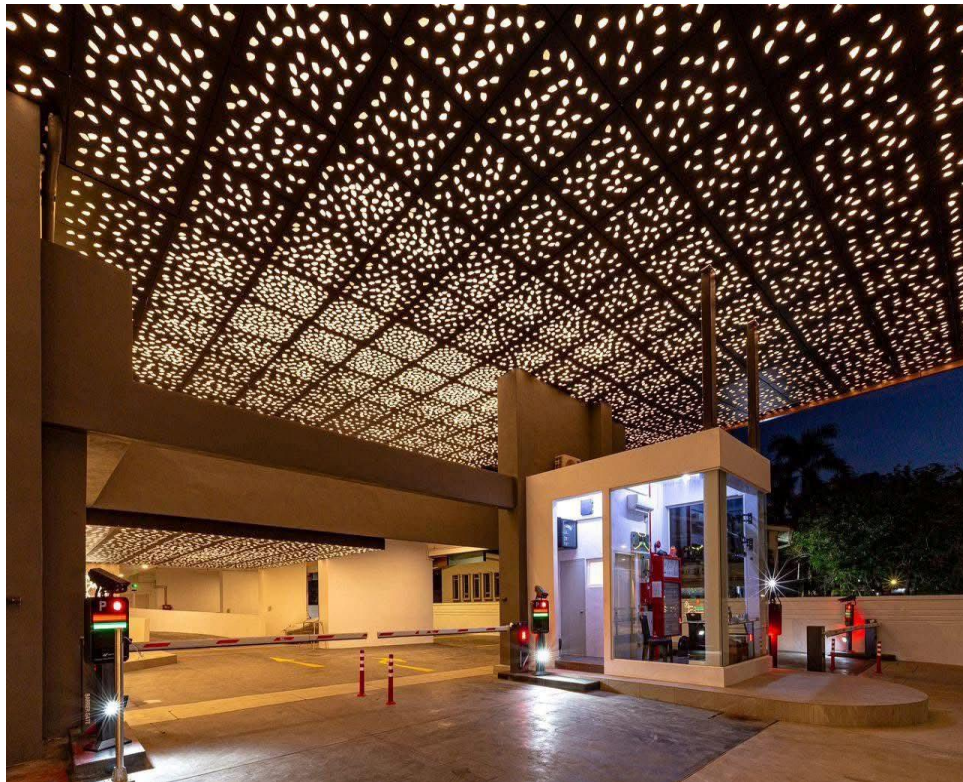
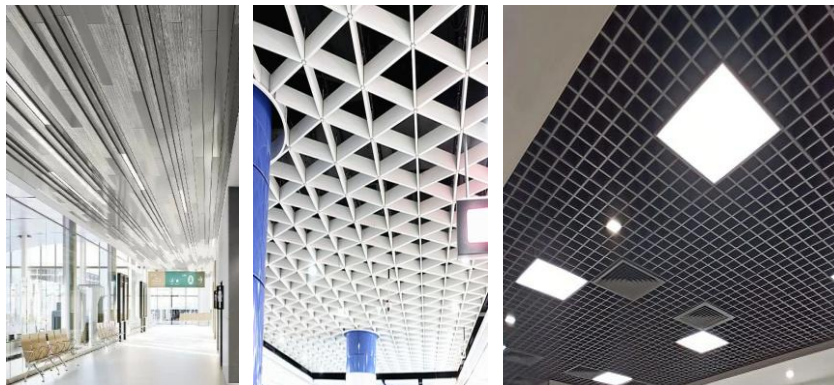
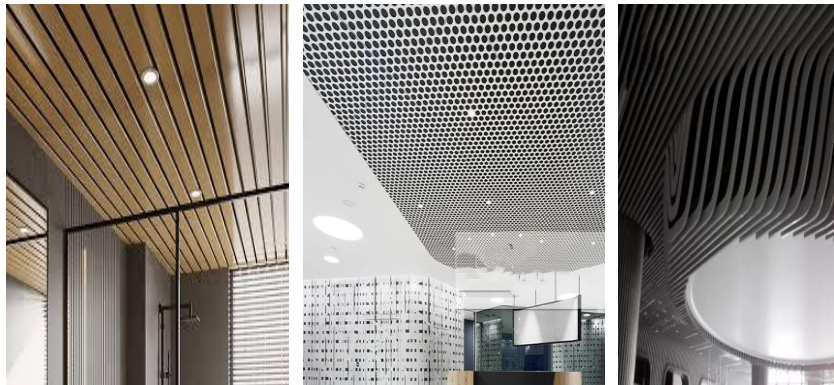

LOUVERS & MASHRABIYA

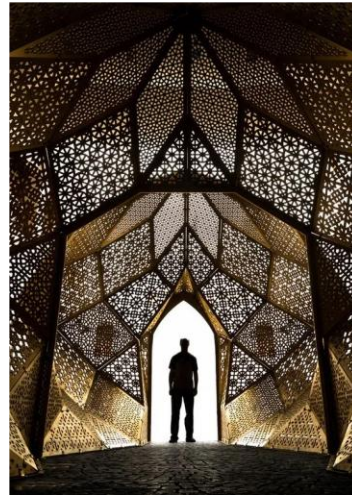

METAL WIRE MESH & GALVANIZED (GI)

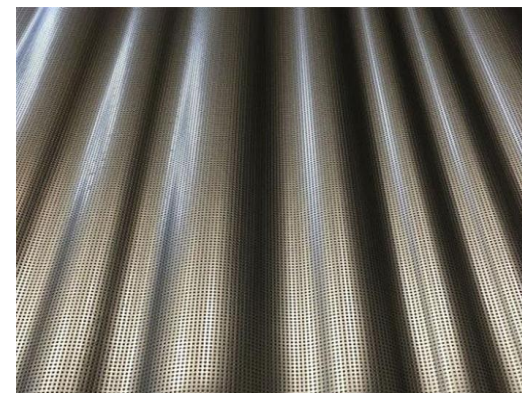
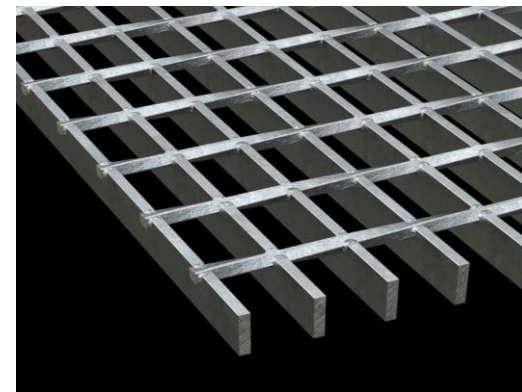
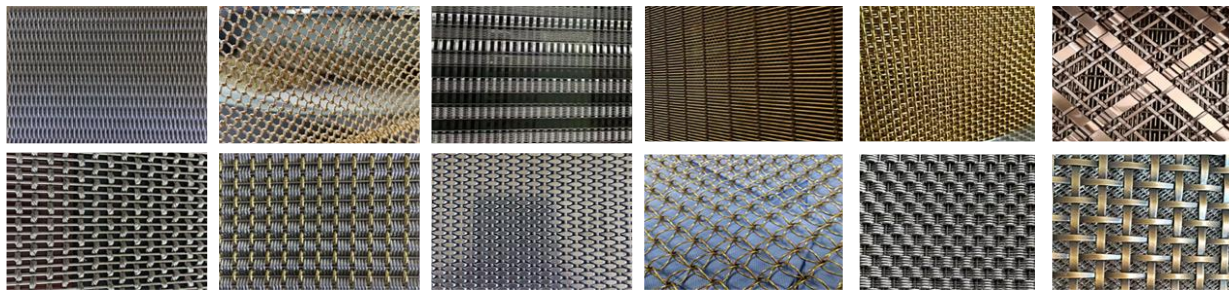

DECORATIVE ALUMINIUM & METAL WORK



HE Metal

ENTRANCE DOORS & FLY SCREENS

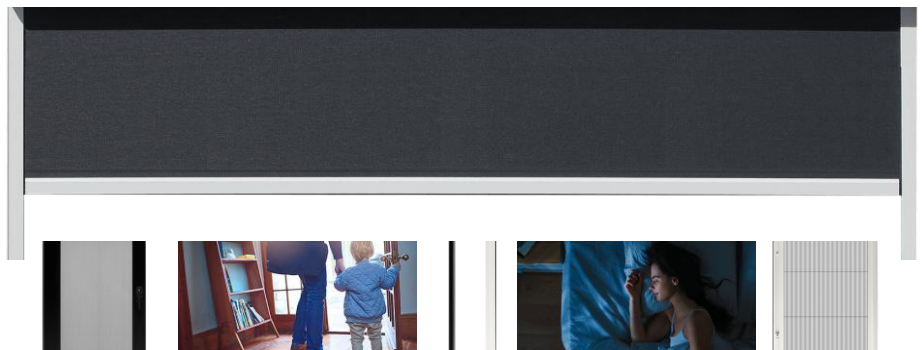
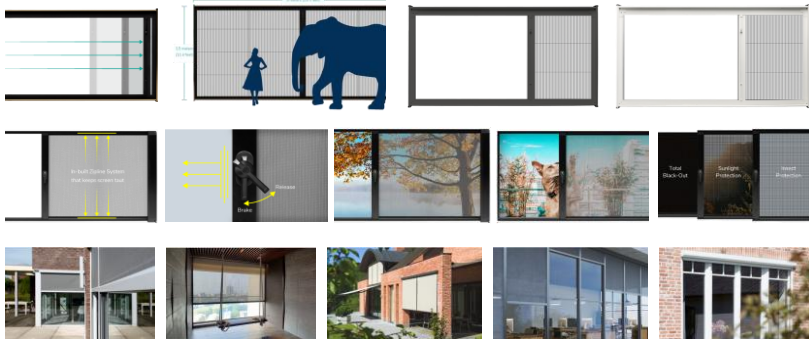
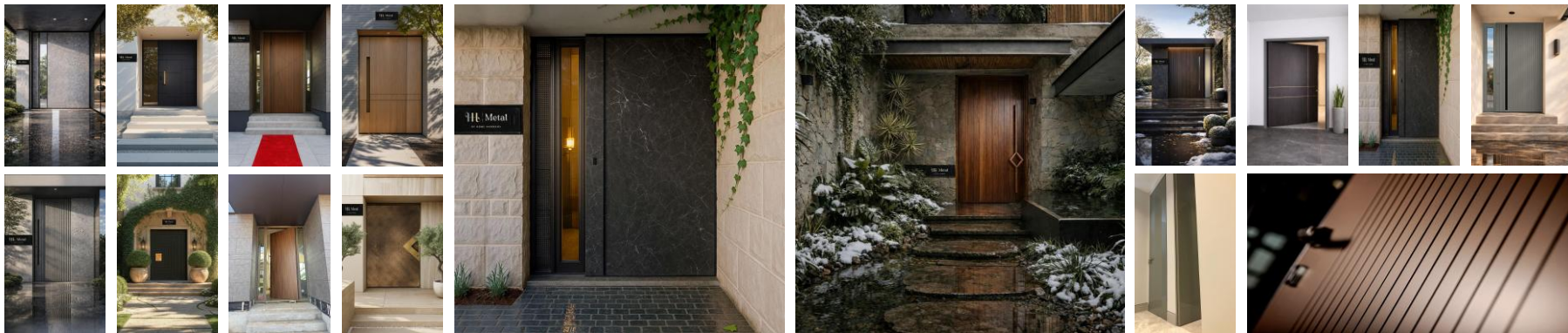

HH Metal

SHADING SYSTEM

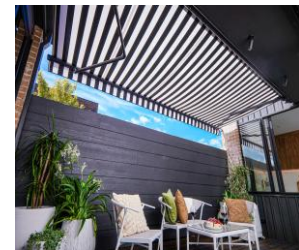

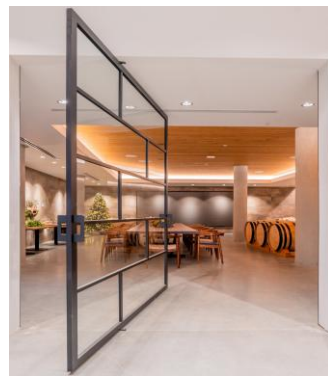
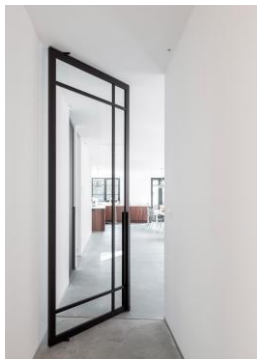

RAILING SYSTEMS

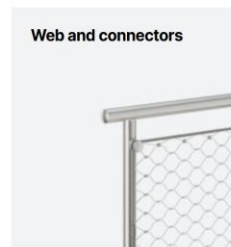
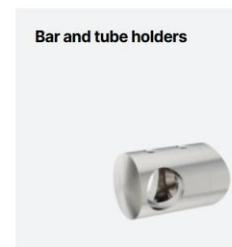
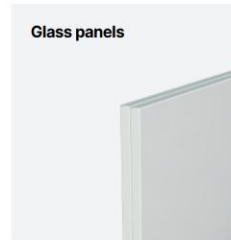

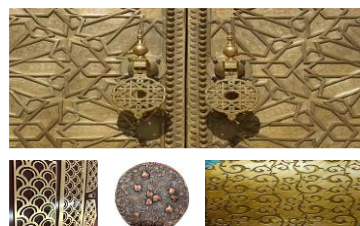
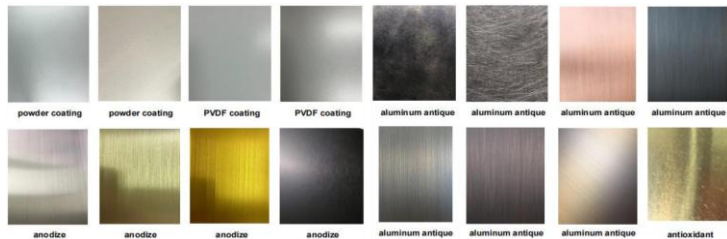
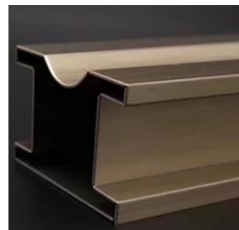
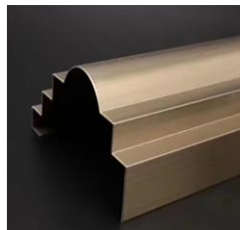
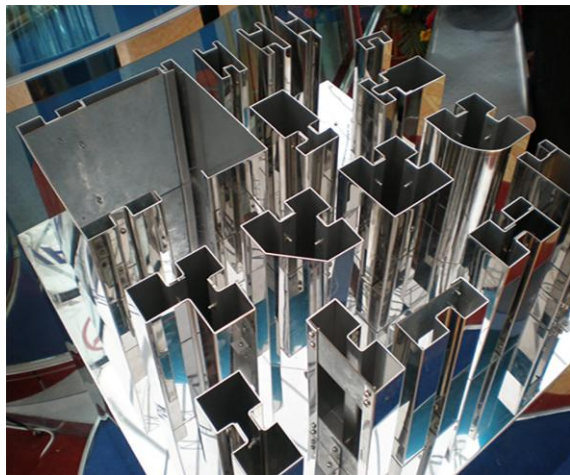



03

OUR PROJECTS

Completed many residential and commercial projects in the UAE and is currently engaged in several ongoing projects.





Project: HH034 – Al Jadaf, Dubai - UAE Enterprises LLC
Consultant: Future Art Engineering Co.
Year: 2025
Scope of Work: Metal Work



Project: HH013 – JVC, Dubai
Consultant: KWEC
Year: 2025
Scope of Work: Pergola



Project: HH029 - Al Jubail Island, AUH
Consultant: Lead | **Year:** 2025
Scope of Work: Mashrabya & Metal Work



Project: HH023 - Discovery Dunes Dubai
Consultant: Olsen and Partners
Year: 2025 | **Scope of Work:** Greeter & Comfort Station



Project: HH004 – Nad Al Sheba, Dubai
Consultant: Designer East
Year: 2025 | **Scope of Work:** Car Parking Pergola/Shades



Project: HH007 – Al Awir, Dubai
Consultant: Designer East
Client: Suhail, Saeed & Hamda | **Year:** 2025
Scope of Work: Metal & Decorative work



Project: HH008 – Jumeirah, Dubai
Consultant: Mivido Factor
Client: Private | **Year:** 2025
Scope of Work: Metal Work



Project: HH0010 – Al Awir, Dubai
Consultant: Designer East
Client: Suhail | **Year:** 2025
Scope of Work: Pivot Door



Project: HH011 – Jumeirah, Dubai
Consultant: Mivido Factor
Client: Private | **Year:** 2025
Scope of Work: Metal Work



Project: HH026 – District 1, Dubai
Consultant: MJU Group
Year: 2025
Scope of Work: Mashrabya



Project: HH027 – District 1, Dubai
Consultant: Designer East
Year: 2025
Scope of Work: Metal Work



Project: HH028 – District 1, Dubai
Consultant: MJU Group
Year: 2025
Scope of Work: Mashrabiya



Project: HH100 – Nad Al Shiba Villa, Dubai
Consultant: DE Consultant
Year: 2026
Scope of Work: Aluminium Cladding & Canopy Work



Project: HH002 - Nad Al Sheba, Dubai
Consultant: Designer East | **Client:** Muzibur
Year: 2025
Scope of Work: Aluminium Work



Project: HH030 – LL037 Villa 22
Consultant: Luxland Landscaping
Year: 2025
Scope of Work: Vertical Garage Door



Project: HH038 – Sharjah
Consultant: Kallos Interior Decor
Year: 2025
Scope of Work: Skylight Work



Project: HH033 – Khasbath Al Reem
Consultant: Saraya Interior Design & Contracting
Year: 2025
Scope of Work: Balustrade, Pergola & Louver



Project: HH040 – Waterfall Villa, Al Zubara Island
Consultant: Saraya Interior Design & Contracting
Year: 2025
Scope of Work: Metal Work

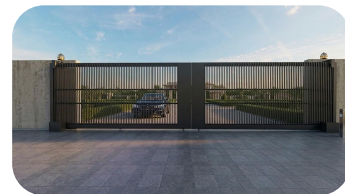

Project: HH050 – Al Nasr - C162 - The Melgrano - ITT - Gates Package
Contractor: Al Nasr Contracting Company LLC
Year: 2026
Scope of Work: Gates



Project: HH036 – Al Manara Villa – Dubai
Consultant: PEROrient Building Contracting LLC
Year: 2025
Scope of Work: Metal Work

HH034
AL JADAF
DUBAI



HH Metal



HH013
JVC
DUBAI



HH Metal



HH013 – JVC DUBAI PROJECT HIGHLIGHT

Project: HH013 – JVC, Dubai
Consultant: KWEC
Year: 2025
Scope of Work: Pergola

HH Metal



HH029
AL JUBAIL ISLAND
ABU DHABI

HH Metal



HH023
DISCOVERY DUNES
DUBAI SOUTH

HH Metal



HH023 - DISCOVERY DUNES DUBAI SOUTH, PROJECT HIGHLIGHT

Project: HH023 - Discovery Dunes Dubai
Consultant: Olsen and Partners
Year: 2025 | **Scope of Work:** Greeter
& Comfort Station

HH Metal

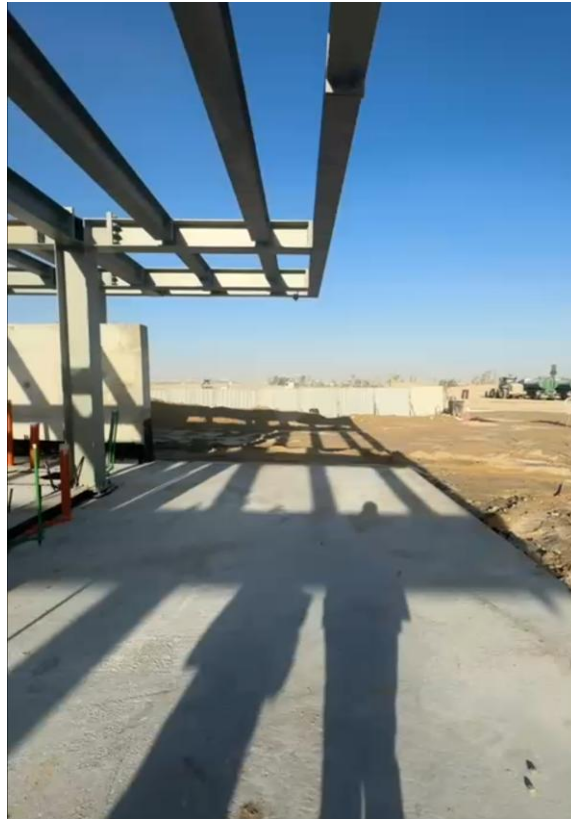

HH004
NAD AL SHEBA 3
DUBAI

HH Metal



HH004 - NAD AL SHEBA 3, DUBAI PROJECT HIGHLIGHT

Project: HH004 – Nad Al Sheba, Dubai

Consultant: Designer East

Year: 2025

Scope of Work: Car Parking Pergola/Shades

HH Metal

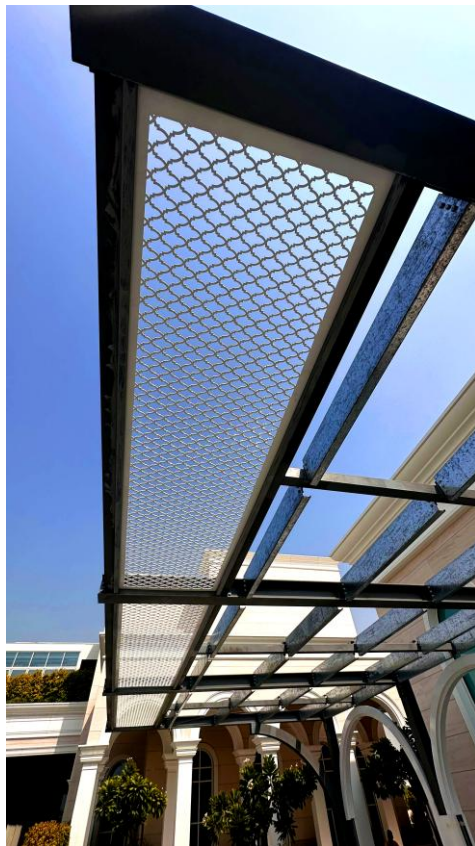

HH007
AL AWIR
DUBAI

HH Metal



HH007 - AL AWIR, DUBAI PROJECT HIGHLIGHT

Project: HH007 – Al Awir, Dubai

Consultant: Designer East

Client: Suhail, Saeed & Hamda | **Year:** 2025

Scope of Work: Metal & Decorative work

HH Metal



HH008
JUMEIRAH
DUBAI

HH Metal



HH0010
AL AWIR
DUBAI

HH Metal



HH0010 - AL AWIR, DUBAI PROJECT HIGHLIGHT



Project: HH0010 – Al Awir, Dubai

Consultant: Designer East

Client: Suhail

Year: 2025

Scope of Work: Pivot Door

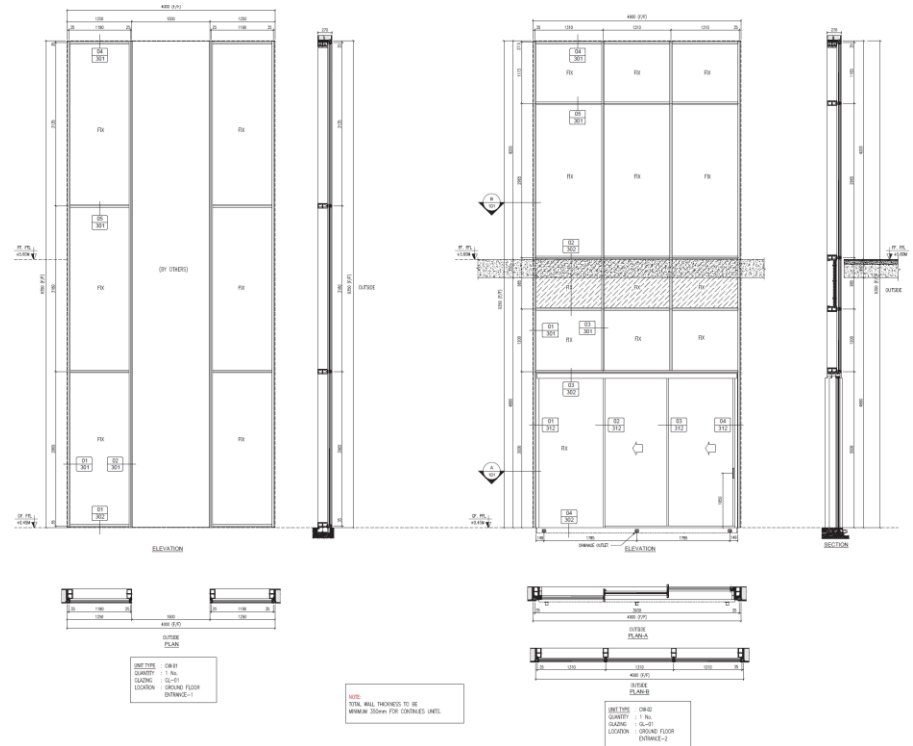

HH0010 - AL AWIR, DUBAI PROJECT HIGHLIGHT

Project: HH0010 – Al Awir, Dubai

Client: Suhail

Scope of Work: Pivot Door

Consultant: Designer East

Year: 2025

HH Metal



HH011
JUMEIRAH
DUBAI

HH Metal



HH011 – JUMEIRAH, DUBAI PROJECT HIGHLIGHT

Project: HH011 – Jumeirah, Dubai
Consultant: Mivido Factor
Client: Private | **Year:** 2025
Scope of Work: Metal Work

HH Metal



HH026
DISTRICT 1
DUBAI

HH Metal



HH026 - DISTRICT 1, DUBAI PROJECT HIGHLIGHT

Project: HH026 – District 1, Dubai
Consultant: MJU Group
Year: 2025
Scope of Work: Mashrabya

HH Metal

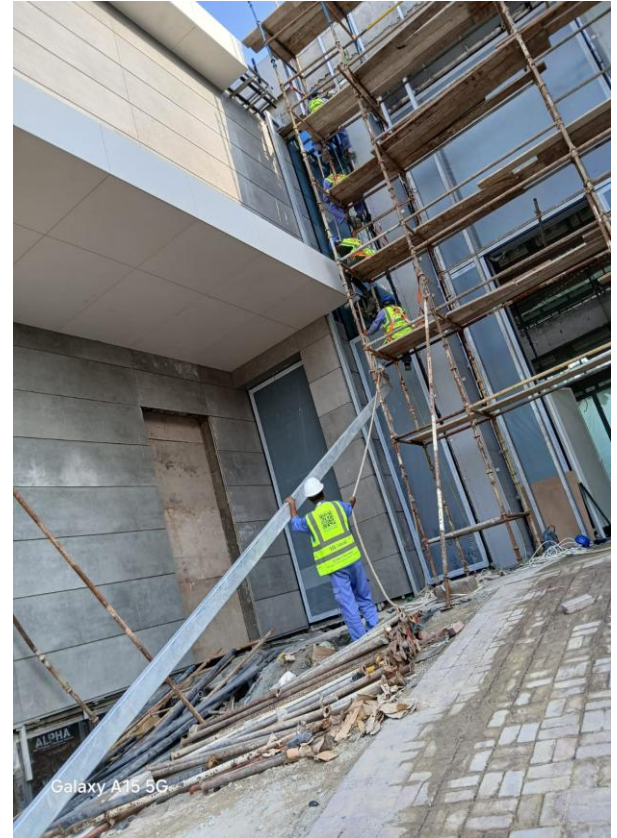

HH027
DISTRICT 1
DUBAI

HH Metal



HH027

ALGEDRA

HH027

HH027 - DISTRICT 1, DUBAI PROJECT HIGHLIGHT

Project: HH027 – District 1, Dubai
Consultant: Designer East
Year: 2025
Scope of Work: Metal Work

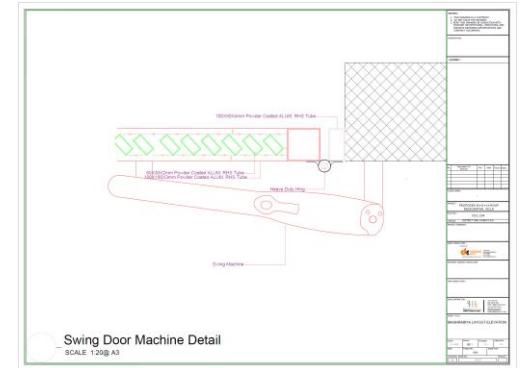
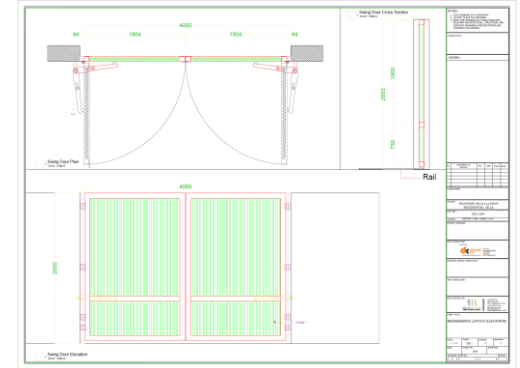

HH028
DISTRICT 1
DUBAI

HH Metal



HH028 - DISTRICT 1, DUBAI PROJECT HIGHLIGHT

Project: HH028 – District 1, Dubai

Consultant: MJU Group

Year: 2025

Scope of Work: Mashrabiya

HH Metal

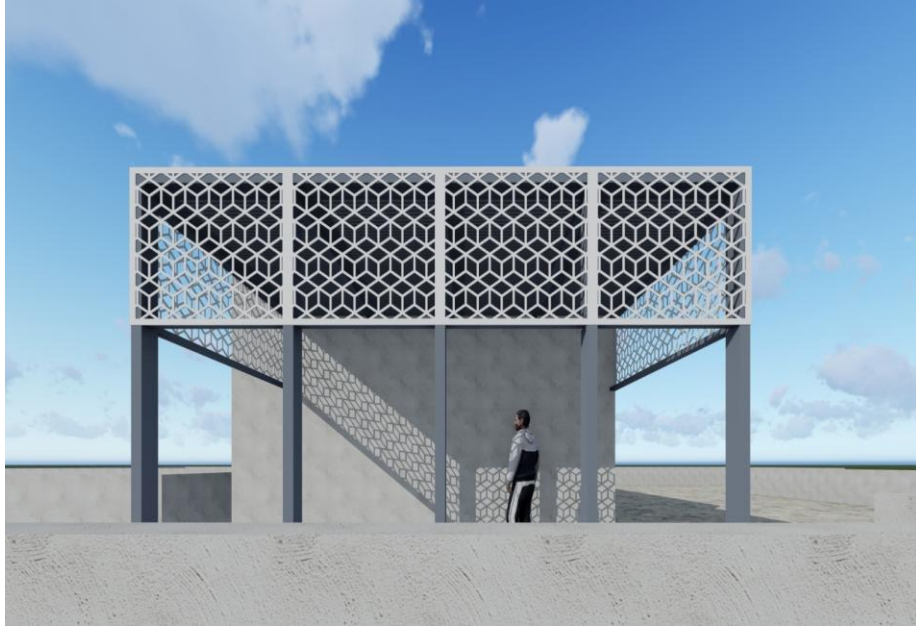

HH100
NAD AL SHIBA
DUBAI

HH Metal



HH002
NAD AL SHEBA
DUBAI

HH Metal



HH030
LL037
VILLA 22



HH030 - LL037 VILLA 22 PROJECT HIGHLIGHT

Project: HH030 – LL037 Villa 22
Consultant: Luxland Landscaping
Year: 2025
Scope of Work: Vertical Garage Door

HH Metal



HH038
SHARJAH

HH Metal



HH038 – SHARJAH PROJECT HIGHLIGHT

Project: HH038 – Sharjah
Consultant: Kallos Interior Decor
Year: 2025
Scope of Work: Skylight Work

HH Metal



HH040
WATERFALL VILLA
AL ZUBARA ISLAND

HH Metal



HH050
THE MELGRANO
DUBAI

HH Metal



HH036
AL MANARA VILLA
DUBAI

HH Metal



IRAQI FLAVOR RESTAURANT

HB Metal





**IRAQI FLAVOR
RESTAURANT**

Metal

مطعم النكهة العراقية
Iraqi Flavor Restaurant

IRAQI FLAVOR
RESTAURANT



IRAQI FLAVOR RESTAURANT

HB Metal



IRAQI FLAVOR
RESTAURANT

М Metal



IRAQI FLAVOR RESTAURANT

HB Metal



Material Inspection



Surface Inspection



Film Inspection



Package Inspection



Delivery





Fiber Laser



Hydraulic Bending



Hydraulic CNC Angle Cutting Shearing



Drilling Milling



Roller Plate Rolling



Hydraulic Section Bending

FIBER LASER MACHINE

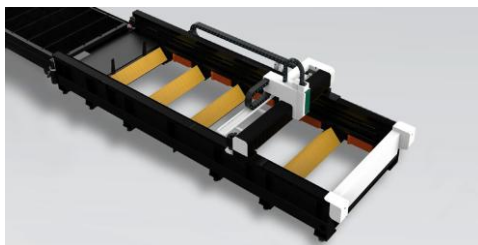

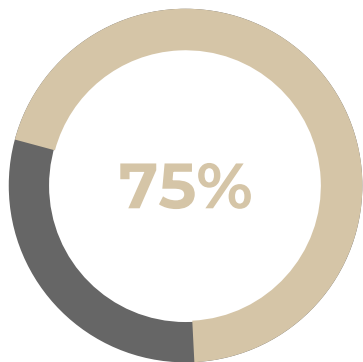

QUALITY & WARRANTY

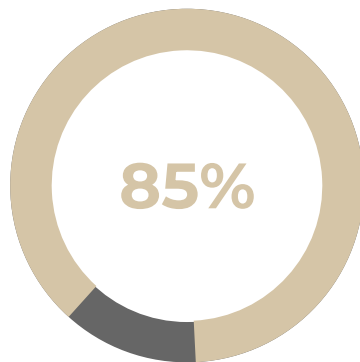

PROFESSIONAL TEAM

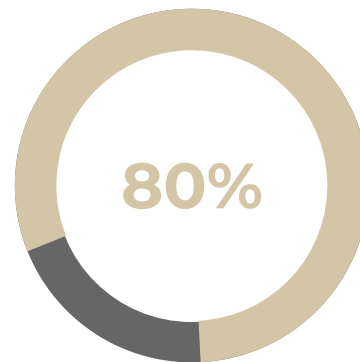

SERVICE DURATION

OUR SUPPLIERS



HB Metal

**APPROVED BY
(MAJOR CLIENT'S DEVELOPERS)**

**JUMEIRAH
ISLANDS**

ميدان
meydan

Jumeirah™

Imdaad

DAMAC

مجمع دبي
للإستثمار
Dubai Investments Park

H Metal

APPROVED BY (MAJOR CLIENT'S CONTRACTORS & CONSULTANTS)



MIVIDO · FAKTUR



HM Metal

APPROVED BY (MAJOR CLIENT'S CONTRACTORS & CONSULTANTS)



H Metal

**APPROVED BY
(MAJOR CLIENT'S CONTRACTORS & CONSULTANTS)**



Diar Consult 

BEST

**Bureau of Engineering Studies
Consulting Engineers**



04

OUR CONTACT & LOCATION

Head office is located in Dubai,
with our manufacturing factory
based in Umm Al Quwain
United Arab Emirates.



HH-METAL HEAD OFFICE

Office 5, Ground Floor
KOA Canvas, Wadi Al Safa 3
Dubai, United Arab Emirates

+971 54 330 8707 | +971 4 261 9744
info@homeharmony.ae | www.hhmetal.ae



OUR FACTORY LOCATION

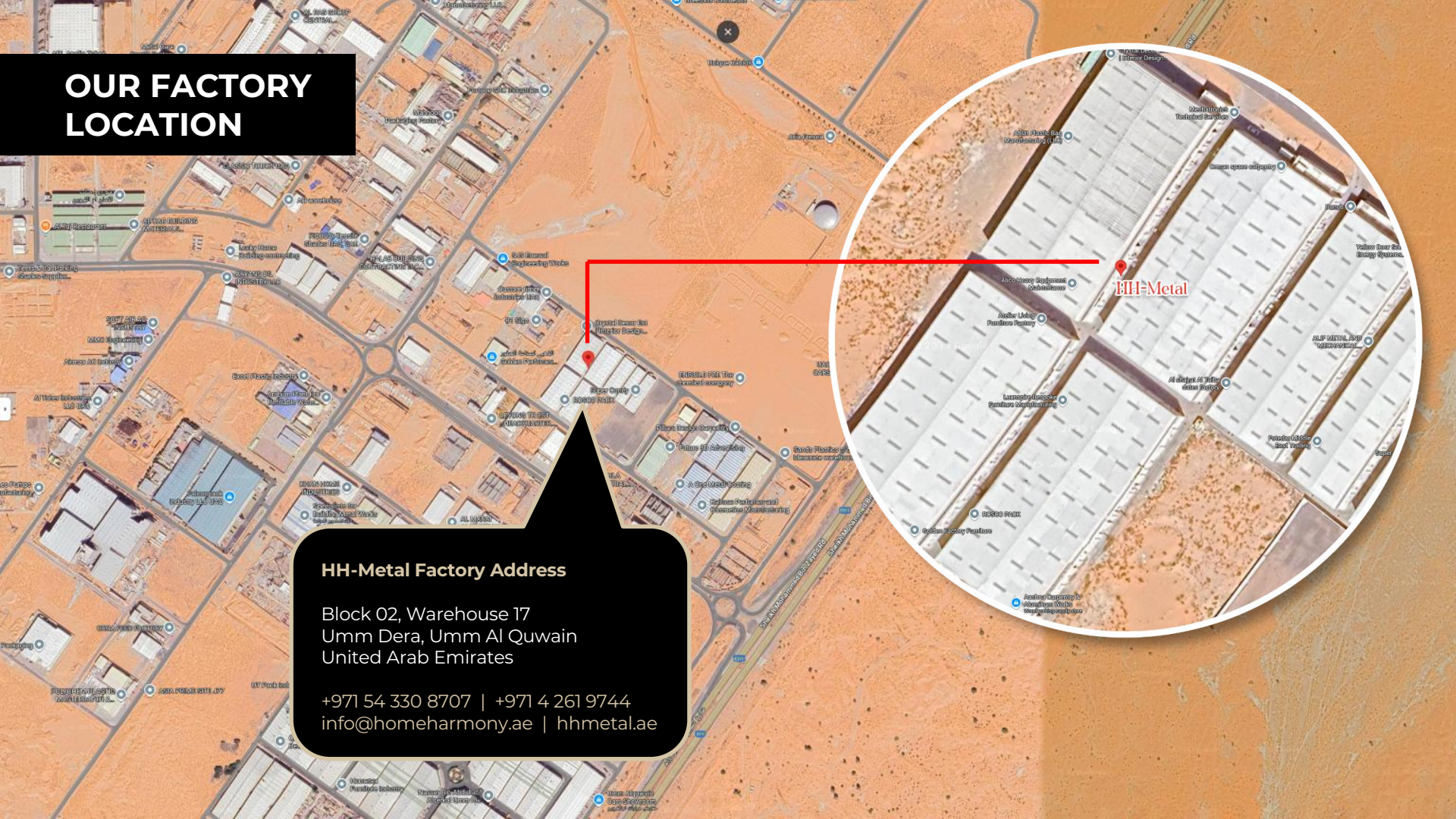

HH-Metal Factory Address

Block 02, Warehouse 17
Umm Dera, Umm Al Quwain
United Arab Emirates

+971 54 330 8707 | +971 4 261 9744
info@homeharmony.ae | hhmetal.ae

OUR TEAM

HH Metal



ORGANIZATION

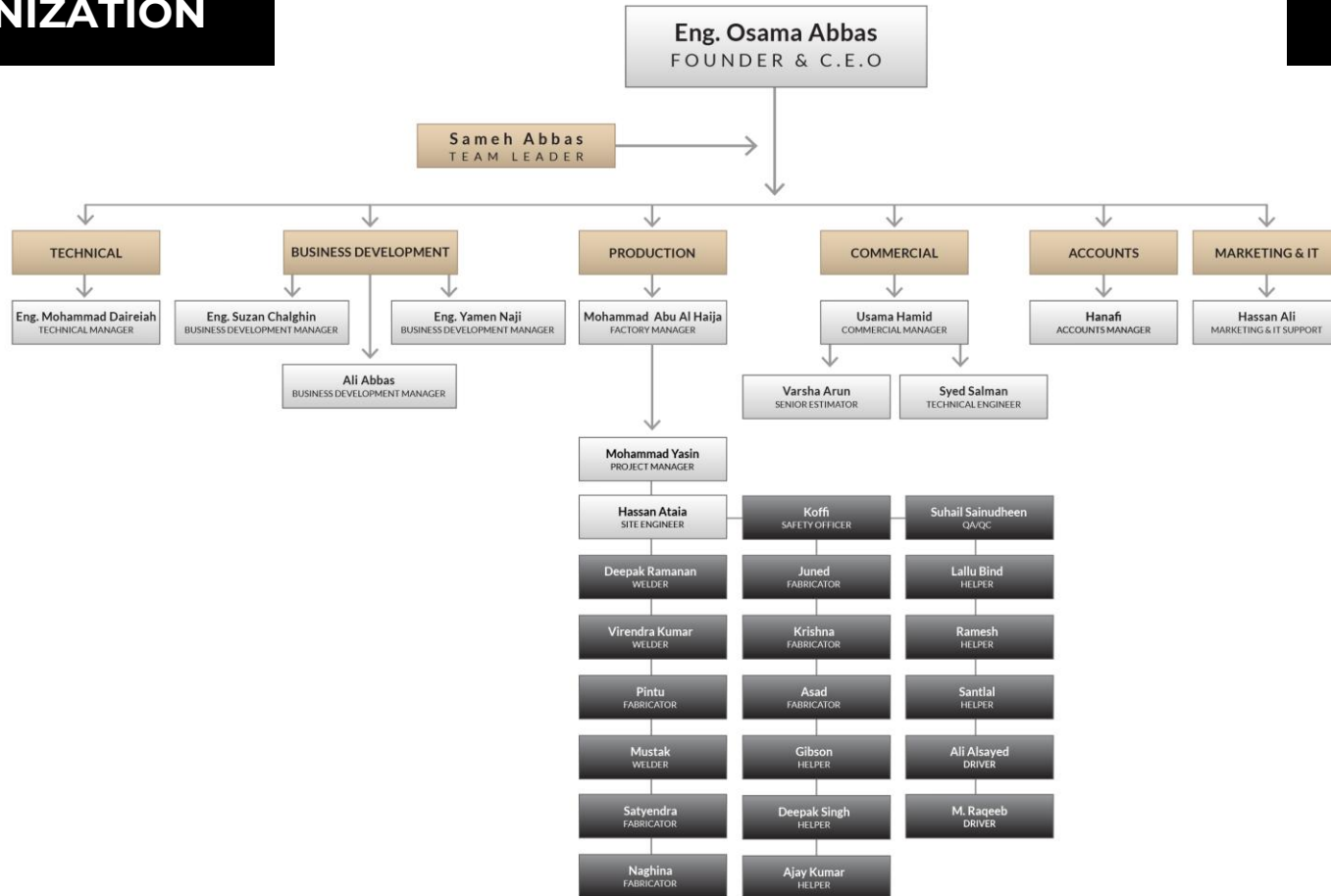

OUR
FACTORY

HOME HARMONY
METAL

BLACKSMITHING AND ALUMINIUM WORKS



050-8319882

هوم هارموني
ميتال

للعمال الحدادة و الالمبيوم

info@homeharmony.ae





THANKS

Contact us:

info@homeharmony.ae

[+971 54 330 8707](tel:+971543308707)

www.hhmetal.ae

